

CADSEEK Analytics



Big Data Intelligence for Engineering Data

CADSEEK Analytics – Sample Report

This sample report is a truncated version of a CADSEEK Analytics report generated from a real-world dataset of 12,009 models published on the Internet by a multinational manufacturer of automation products.

- The dataset is composed of numerous formats for both parts and assemblies including .prt, .model, .stp, .sat, and .igs.
- Compiling the report required 144,204,072 comparisons (12,009 x 12,008). Total running time for compiling was 4 minutes and 39 seconds using an HP Envy TS 15 Notebook PC with AMD A10-5750M chip and 8 GB of RAM.
- The similarity threshold was set to 85%, i.e., *show all models that have at least one model with 85% or greater similarity*. 11,406 models had at least one model within the threshold.
 - Each of the 11,406 models has a line in the report where the larger model on the left is the model of interest, and all similar models are shown as smaller thumbnails on the right. OF NOTE is CADSEEK's ability to classify the results without clutter.
 - The report is compiled as 229 page views, with 50 lines (models) on each page view. Each page view would require multiple standard printer pages to print. For example the first page view is 17 standard pages long. Page views 1, 10 and 200 have been extracted from the full report to create this sample report. The report is ranked by average similarity, so a model with 1 identical model would rank high. The third page view, beginning on roughly page 58 of this sample is where models with visible differences can be seen.
- A report can be exported in a delimited format for additional parsing and analysis.
- Reports can be run within or across datasets, which is extremely useful for acquisitions.
- Any available meta-data filters can be applied, i.e., *at 90% similarity show all models with the attribute 'stainless.'*
- Available reports in the CADSEEK Analytics package include:
 - Dataset overview
 - Duplication report
 - Similarity report
 - Meta-data report
 - Missing Dependencies report
 - Failed Models Report

The Dataset Overview report (below) shows the number of models that have similarity within a given range. For example, 14,298 models have another model in the dataset with 98% to 99.999% similarity. This report will count an individual model more than once.

Dataset Overview Report

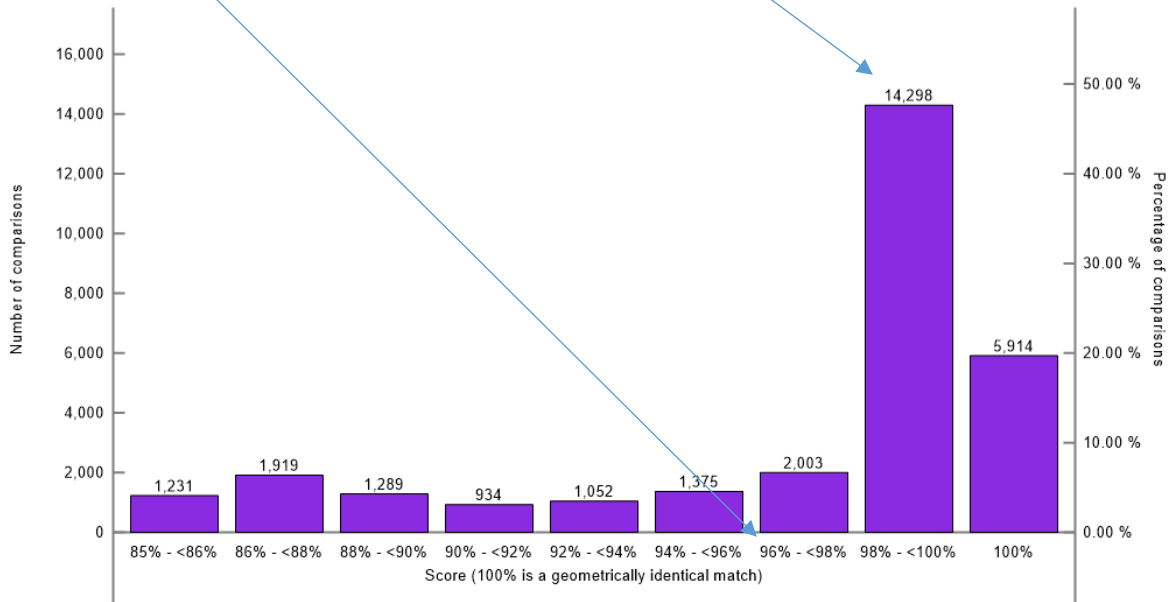

[Return to Analytics Reports page](#)

The following pages of this document are extracted from the Similarity Report. In total, the Similarity report for the dataset being analyzed would be over 1,000 standard printer pages.

CADSEEK Analytics is available as software or as a service, either directly from iSEEK Corp, or through an engineering services provider. You can learn more about CADSEEK Analytics at <https://www.iseekcorp.com/analytics>. For more information please email us at info@iseekcorp.com or 515.296.4156.

Shape Analytics of different-named models in dataset [REDACTED] with 85.00 % cutoff (11406 groups equivalent to 30015 pairs of matches)

The left column displays each model in the dataset [REDACTED] that has one or more matching parts in the same dataset. The right column displays each of these matching parts. Each entry in the right column has a score between 0% and 100%, where 100% indicates an exact geometric match.

Results per page: Go to page:

Page: [prev](#) | [1](#) | [2](#) | [3](#) | [4](#) | [5](#) | [6](#) | [7](#) | [8](#) | [9](#) | [10](#) | ... | [229](#) | [next](#)

[Name](#)

[Similar parts](#)

1. [VADM_045_P.model](#) (2 members)

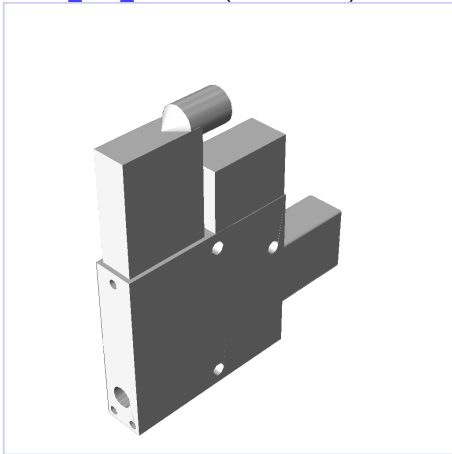

VADM_045_N.m
odel
100.00 %

2. [VADM_045_N.model](#) (2 members)

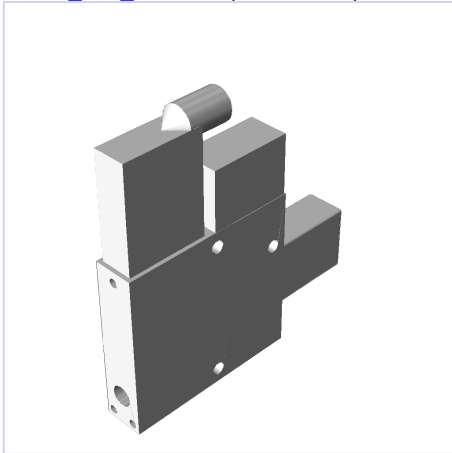

VADM_045_P.m
odel
100.00 %

3. [STAF_32_20_P_A_K.model](#) (2 members)

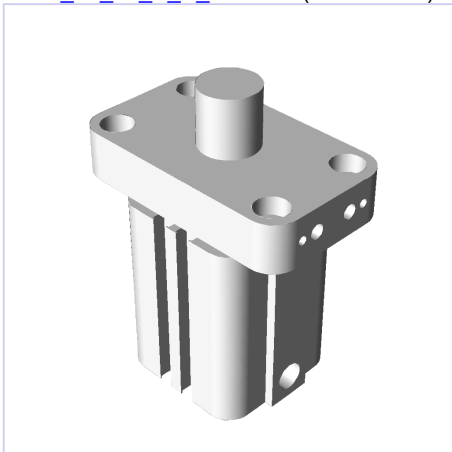

STAF_32_20_P
_A.model
100.00 %

Name

4. [STAF_32_20_P_A.model](#) (2 members)

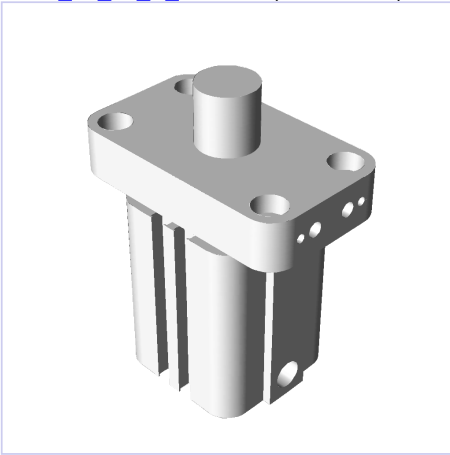

Similar parts



[STAF_32_20_P_A_K.model](#)
100.00 %

5. [ssb_2xjmdd_5_2_d_1c_sa26284_pn184871.prt](#) (3 members)

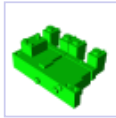
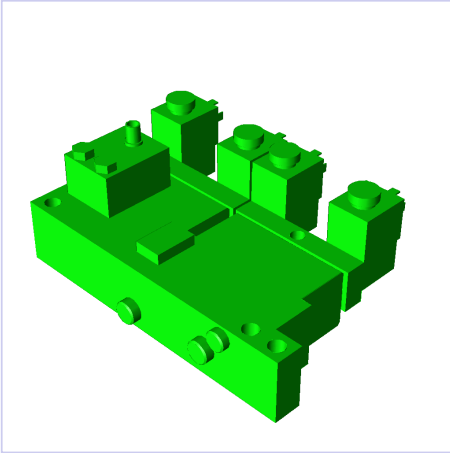

[ssb_2xjmdd_5_2_d_1c_sa26284_pn184871.igs](#)
100.00 %

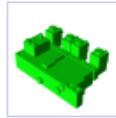

[ssb_2xjmdd_5_2_d_1c_sa26284_pn184871.stp](#)
100.00 %

6. [slg_18_800_p_a.stp](#) (2 members)

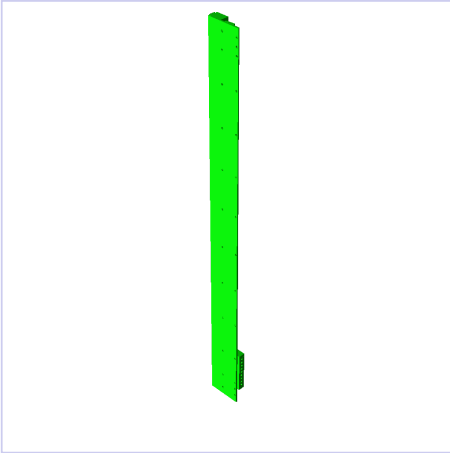

[slg_18_800_p_a.prt](#)
100.00 %

Name

7. [slg_18_800_p_a.prt](#) (2 members)

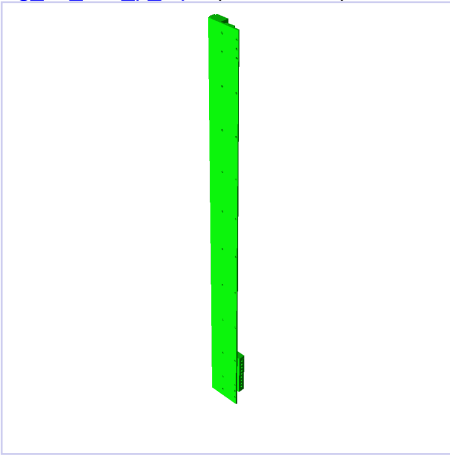

Similar parts



slg_18_800_p_a
.stp
100.00 %

8. [slg_18_600_p_a.stp](#) (2 members)

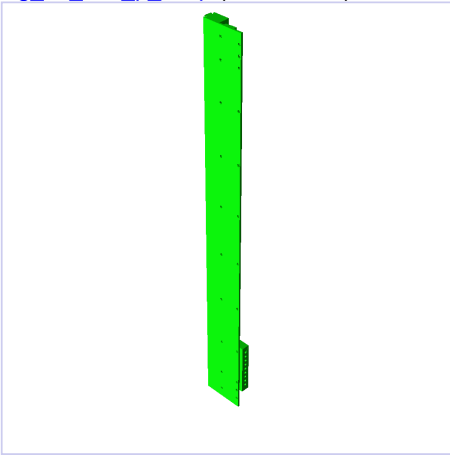

slg_18_600_p_a
.prt
100.00 %

9. [slg_18_600_p_a.prt](#) (2 members)

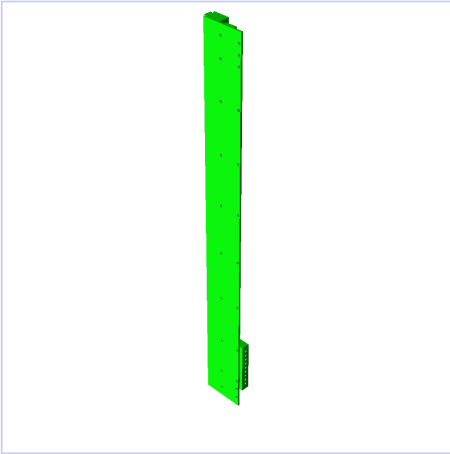

slg_18_600_p_a
.stp
100.00 %

Name

10. [slg_18_500_p_a.stp](#) (2 members)

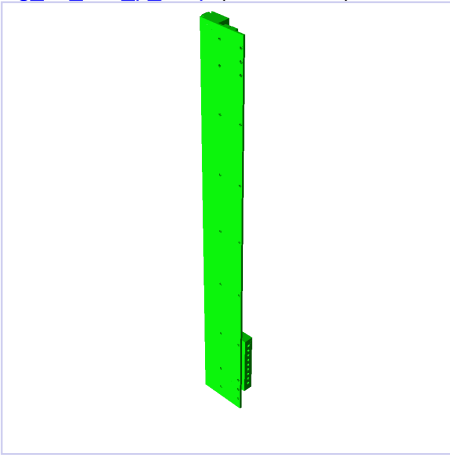

Similar parts



slg_18_500_p_a
.prt
100.00 %

11. [slg_18_500_p_a.prt](#) (2 members)

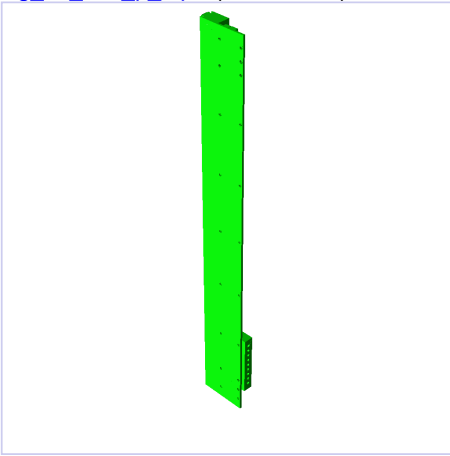

slg_18_500_p_a
.stp
100.00 %

12. [slg_18_300_p_a.stp](#) (2 members)

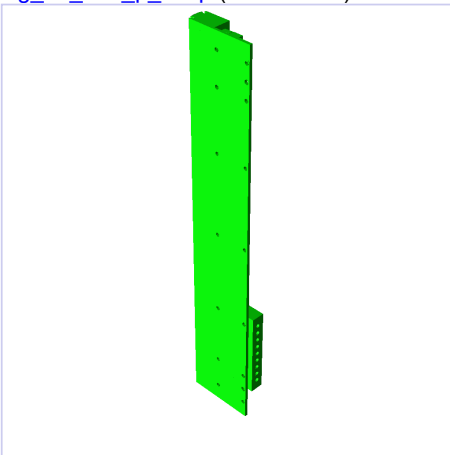

slg_18_300_p_a
.prt
100.00 %

Name

13. [slg_18_300_p_a.prt](#) (2 members)

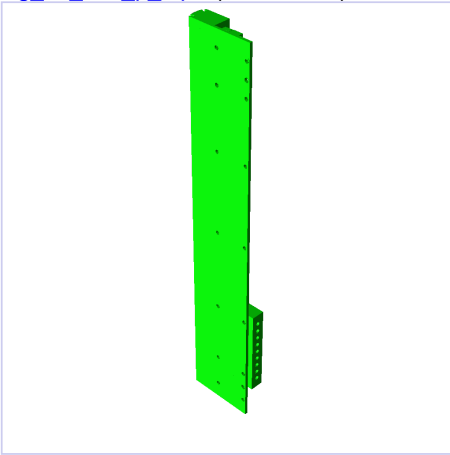

Similar parts



slg_18_300_p_a
.stp
100.00 %

14. [slg_18_200_p_a.stp](#) (2 members)

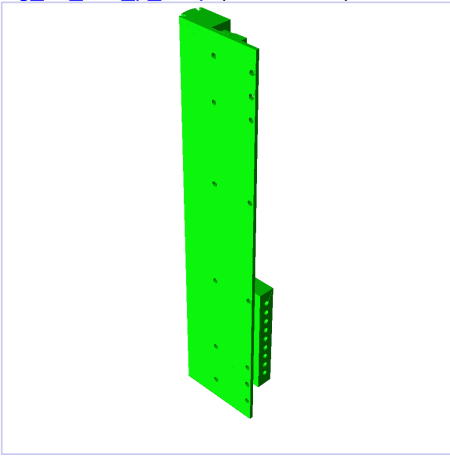

slg_18_200_p_a
.prt
100.00 %

15. [slg_18_200_p_a.prt](#) (2 members)

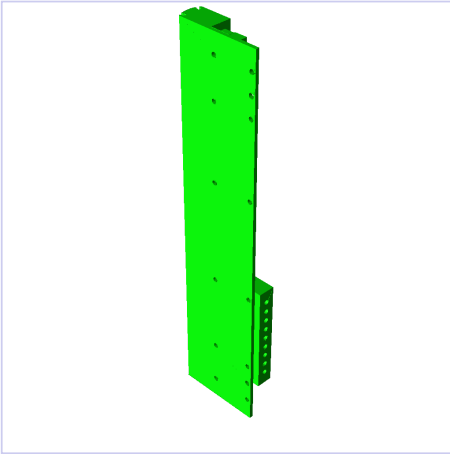

slg_18_200_p_a
.stp
100.00 %

Name

16. [slg_18_100_p_a.stp](#) (2 members)

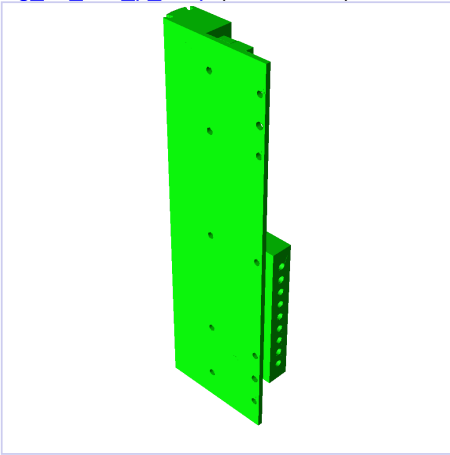

Similar parts



slg_18_100_p_a
.prt
100.00 %

17. [slg_18_100_p_a.prt](#) (2 members)

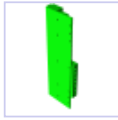
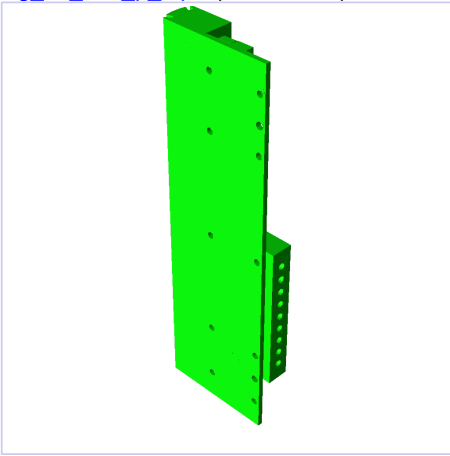

slg_18_100_p_a
.stp
100.00 %

18. [slg_12_700_p_a.stp](#) (2 members)

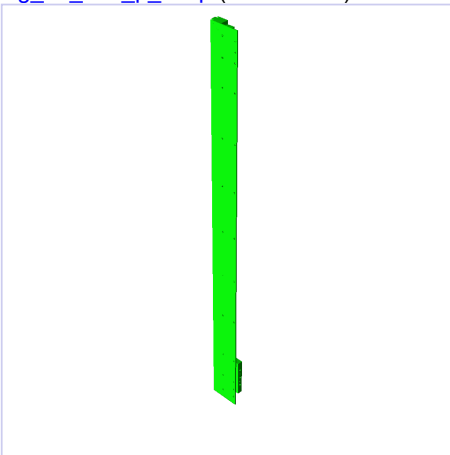

slg_12_700_p_a
.prt
100.00 %

Name

19. [slg_12_700_p_a.prt](#) (2 members)

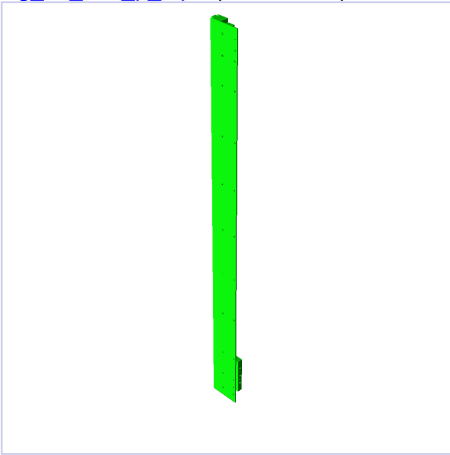

Similar parts



slg_12_700_p_a
.stp
100.00 %

20. [slg_12_400_p_a.stp](#) (2 members)

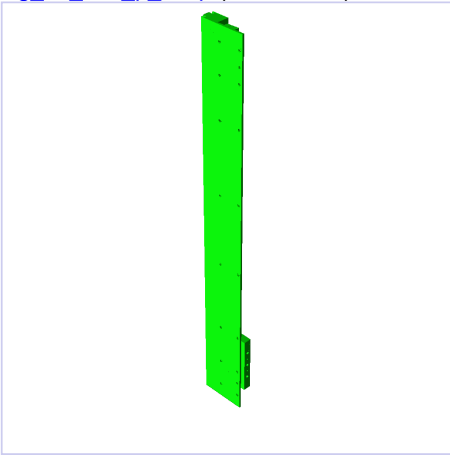

slg_12_400_p_a
.prt
100.00 %

21. [slg_12_400_p_a.prt](#) (2 members)

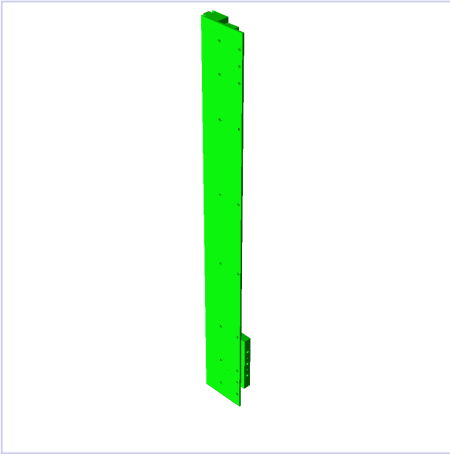

slg_12_400_p_a
.stp
100.00 %

Name

22. [slg_08_200_p_a.stp](#) (2 members)

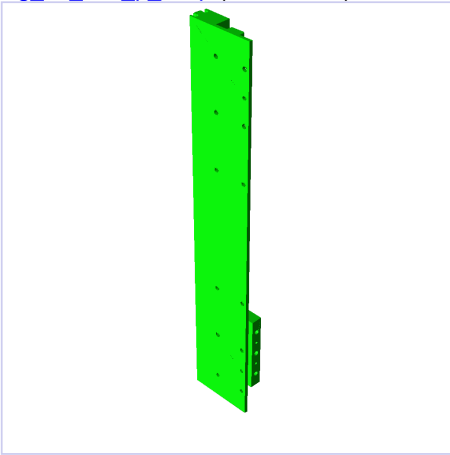

Similar parts



slg_08_200_p_a
.prt
100.00 %

23. [slg_08_200_p_a.prt](#) (2 members)

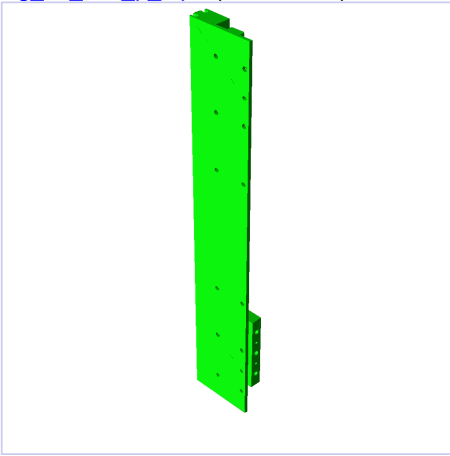

slg_08_200_p_a
.stp
100.00 %

24. [rpmn2h_5-2_1-8_fr_sa202665_pn53277.stp](#) (2 members)

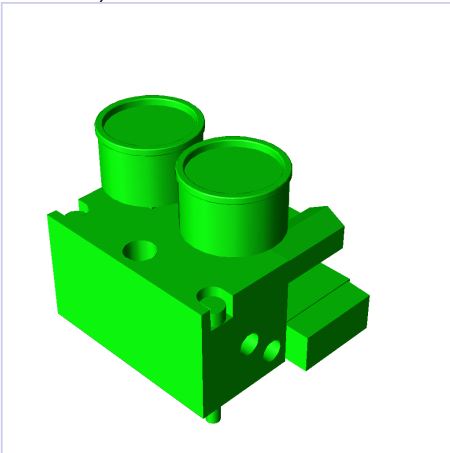

rpmn2h_5-2_1-
8_fr_sa202665_
pn53277.prt
100.00 %

Name

25. [rpmn2h_5-2_1-8_fr_sa202665_pn53277.prt](#) (2 members)

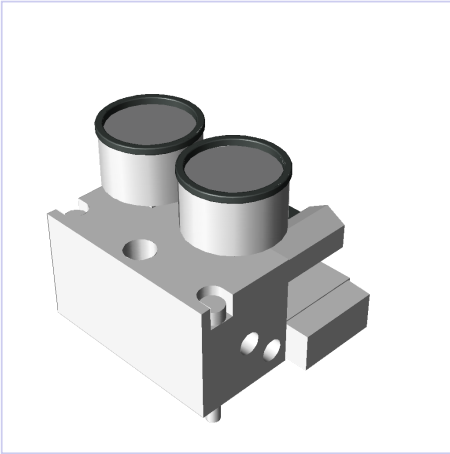

Similar parts



[rpmn2h_5-2_1-8_fr_sa202665_pn53277.stp](#)
100.00 %

26. [nsthl_63_pn158414.stp](#) (3 members)

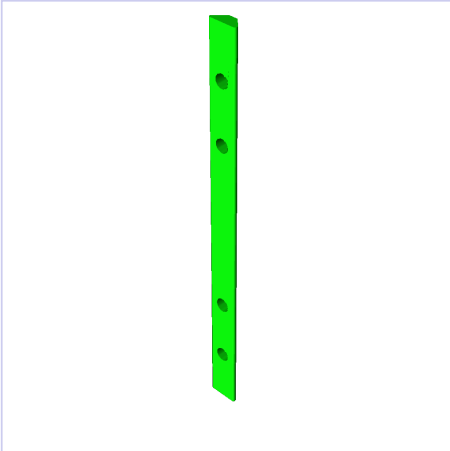

[nsthl_63_pn158414.igs](#)
100.00 %



[nsthl_63_pn158414.prt](#)
100.00 %

27. [nsthl_63_pn158414.prt](#) (3 members)

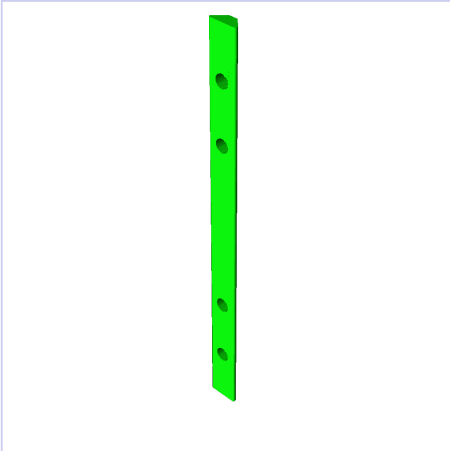

[nsthl_63_pn158414.igs](#)
100.00 %



[nsthl_63_pn158414.stp](#)
100.00 %

Name

28. [nssl_63_pn158414.igs](#) (3 members)

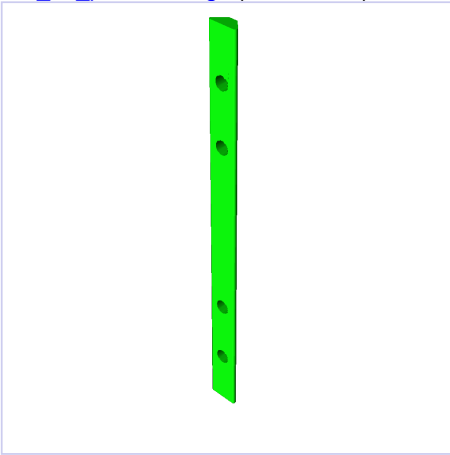

Similar parts



nssl_63_pn1584
14.prt
100.00 %



nssl_63_pn1584
14.stp
100.00 %

29. [feng_040_200_kf.stp](#) (3 members)

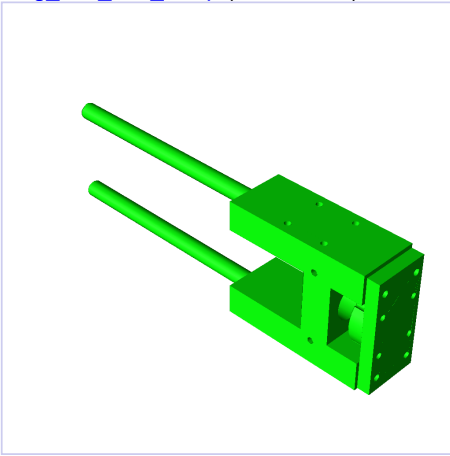

feng_040_200_k
f.igs
100.00 %

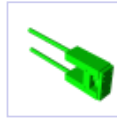

feng_040_200_k
f.prt
100.00 %

30. [feng_040_200_kf.prt](#) (3 members)

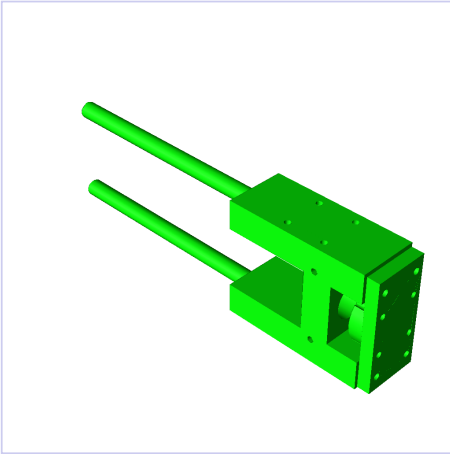

feng_040_200_k
f.igs
100.00 %

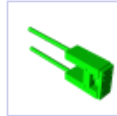

feng_040_200_k
f.stp
100.00 %

Name

31. [feng_040_200_kf.igs](#) (3 members)

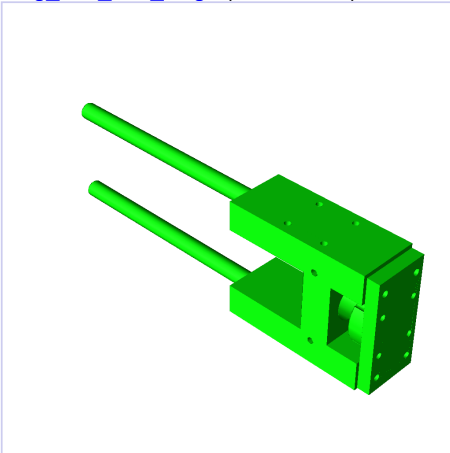

Similar parts



feng_040_200_k
f.prt
100.00 %



feng_040_200_k
f.stp
100.00 %

32. [ezh_2-5-9_20_b_pn164992.stp](#) (3 members)

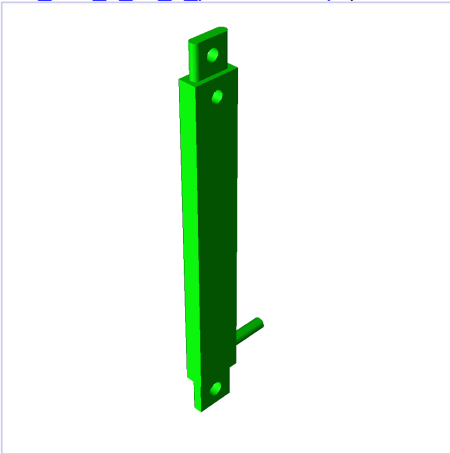

ezh_2-5-
_9_20_b_pn164
992.igs
100.00 %



ezh_2-5-
_9_20_b_pn164
992.prt
100.00 %

33. [ezh_2-5-9_20_b_pn164992.prt](#) (3 members)

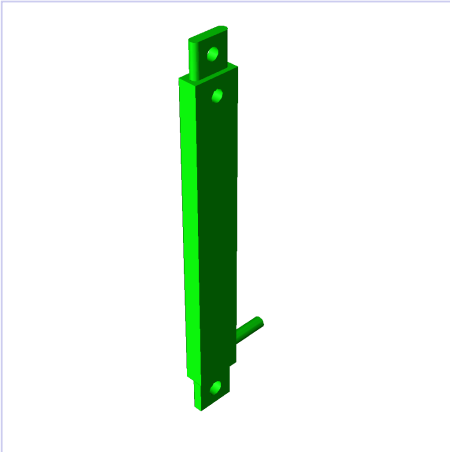

ezh_2-5-
_9_20_b_pn164
992.igs
100.00 %



ezh_2-5-
_9_20_b_pn164
992.stp
100.00 %

Name

34. [ezh_2-5-9_20_b_pn164992.igs](#) (3 members)

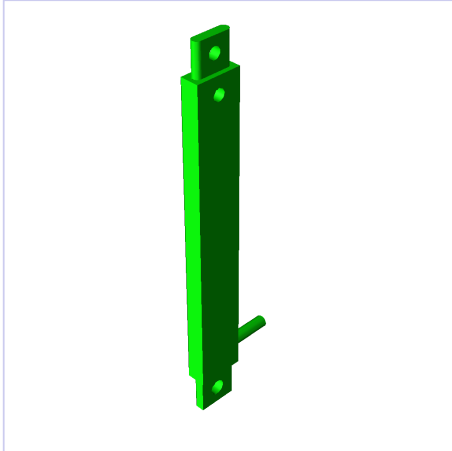

Similar parts



ezh_2-5-
_9_20_b_pn164
992.prt
100.00 %



ezh_2-5-
_9_20_b_pn164
992.stp
100.00 %

35. [dsnu_25_400_ppv_a_s2.stp](#) (9 members)

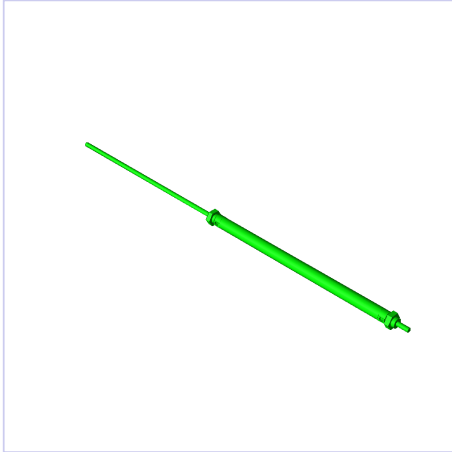

dsnu_25_400_p_
s2.prt
100.00 %



dsnu_25_400_p_
s2.stp
100.00 %



dsnu_25_400_pp
v_s2.igs
100.00 %



dsnu_25_400_pp
v_s2.prt
100.00 %



dsnu_25_400_pp
v_s2.stp
100.00 %



dsnu_25_400_p_
_a_s2.prt
100.00 %



dsnu_25_400_p_
_a_S2.stp
100.00 %



dsnu_25_400_p
pv_a_s2.prt
100.00 %

36. [dsnu_25_400_p_a_S2.stp](#) (9 members)

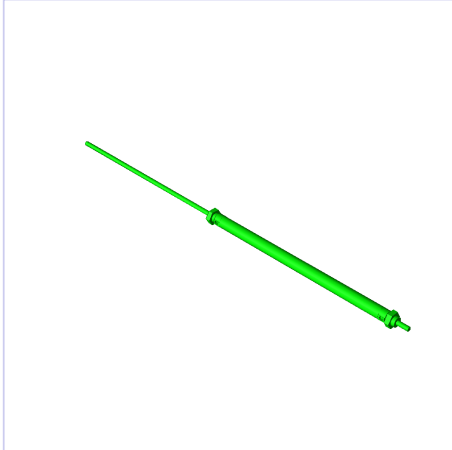

dsnu_25_400_p_
s2.prt
100.00 %



dsnu_25_400_p_
s2.stp
100.00 %



dsnu_25_400_pp
v_s2.igs
100.00 %



dsnu_25_400_pp
v_s2.prt
100.00 %



dsnu_25_400_pp
v_s2.stp
100.00 %



dsnu_25_400_p_
_a_s2.prt
100.00 %



dsnu_25_400_p
pv_a_s2.prt
100.00 %



dsnu_25_400_p
pv_a_s2.stp
100.00 %

Name

37. [dsnu_25_250_ppv_a_s2.stp](#) (9 members)

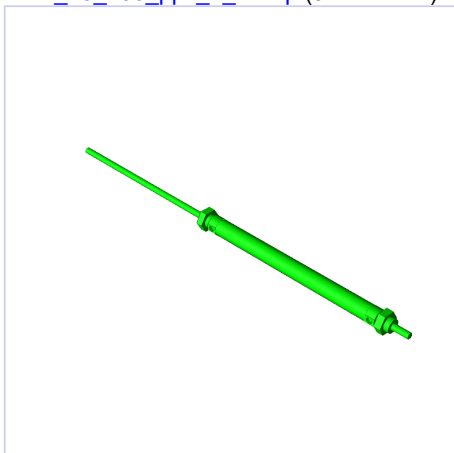

Similar parts



dsn_25_250_p_s2.prt
100.00 %



dsn_25_250_p_s2.stp
100.00 %



dsn_25_250_ppv_s2.igs
100.00 %



dsn_25_250_ppv_s2.prt
100.00 %



dsn_25_250_ppv_s2.stp
100.00 %



dsnu_25_250_p_a_s2.prt
100.00 %



dsnu_25_250_p_a_S2.stp
100.00 %



dsnu_25_250_pv_a_s2.prt
100.00 %

38. [dsnu_25_250_ppv_a_s2.prt](#) (9 members)

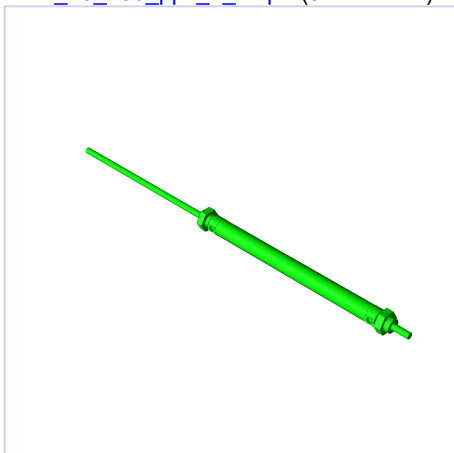

dsn_25_250_p_s2.prt
100.00 %



dsn_25_250_p_s2.stp
100.00 %



dsn_25_250_ppv_s2.igs
100.00 %



dsn_25_250_ppv_s2.prt
100.00 %



dsn_25_250_ppv_s2.stp
100.00 %



dsnu_25_250_p_a_s2.prt
100.00 %



dsnu_25_250_p_a_S2.stp
100.00 %



dsnu_25_250_pv_a_s2.stp
100.00 %

39. [dsnu_25_250_ppv_a_kp.stp](#) (4 members)

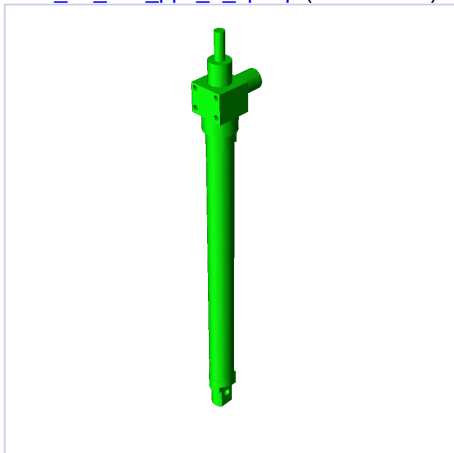

dsnu_25_250_p_a_kp.prt
100.00 %



dsnu_25_250_p_a_kp.stp
100.00 %



dsnu_25_250_pv_a_kp.prt
100.00 %

Name

40. [dsnu_25_250_ppv_a_kp.prt](#) (4 members)

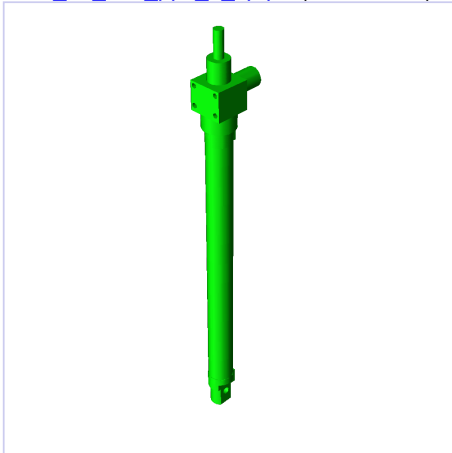

Similar parts



dsnu_25_250_p
_a_kp.prt
100.00 %



dsnu_25_250_p
_a_kp.stp
100.00 %



dsnu_25_250_p
pv_a_kp.stp
100.00 %

41. [dsnu_25_250_p_a_S2.stp](#) (9 members)

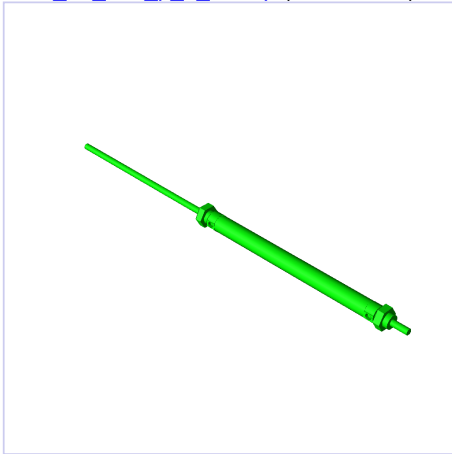

dsn_25_250_p_
s2.prt
100.00 %



dsn_25_250_p_
s2.stp
100.00 %



dsn_25_250_pp
v_s2.igs
100.00 %



dsn_25_250_pp
v_s2.prt
100.00 %



dsn_25_250_pp
v_s2.stp
100.00 %



dsnu_25_250_p
_a_s2.prt
100.00 %



dsnu_25_250_p
pv_a_s2.prt
100.00 %



dsnu_25_250_p
pv_a_s2.stp
100.00 %

42. [dsnu_25_250_p_a_s2.prt](#) (9 members)

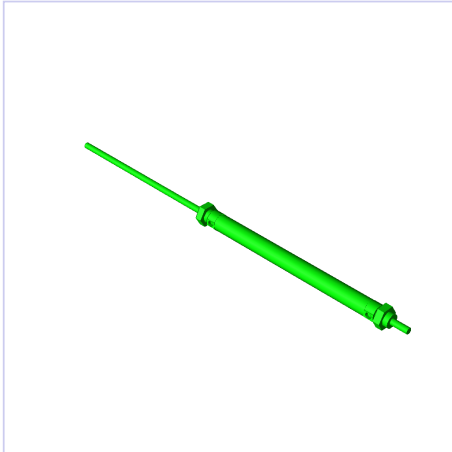

dsn_25_250_p_
s2.prt
100.00 %



dsn_25_250_p_
s2.stp
100.00 %



dsn_25_250_pp
v_s2.igs
100.00 %



dsn_25_250_pp
v_s2.prt
100.00 %



dsn_25_250_pp
v_s2.stp
100.00 %



dsnu_25_250_p
_a_S2.stp
100.00 %



dsnu_25_250_p
pv_a_s2.prt
100.00 %



dsnu_25_250_p
pv_a_s2.stp
100.00 %

Name

43. [dsnu_25_250_p_a_kp.stp](#) (4 members)

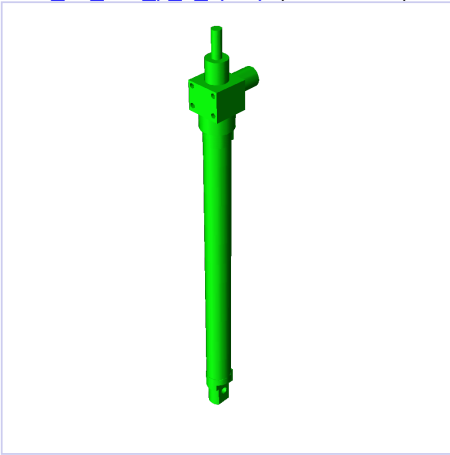

Similar parts



dsnu_25_250_p_a_kp.prt
100.00 %



dsnu_25_250_p_pv_a_kp.prt
100.00 %



dsnu_25_250_p_pv_a_kp.stp
100.00 %

44. [dsnu_25_250_p_a_kp.prt](#) (4 members)

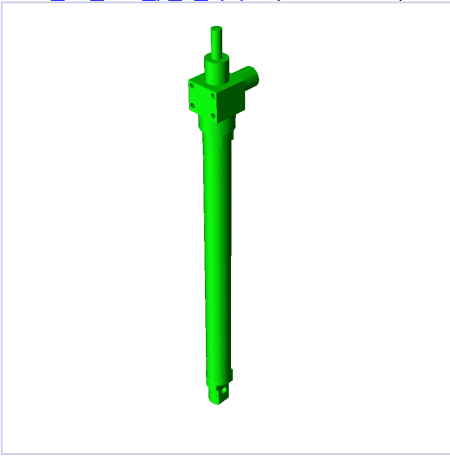

dsnu_25_250_p_a_kp.stp
100.00 %



dsnu_25_250_p_pv_a_kp.prt
100.00 %



dsnu_25_250_p_pv_a_kp.stp
100.00 %

45. [dsnu_25_200_ppv_a_kp.stp](#) (4 members)

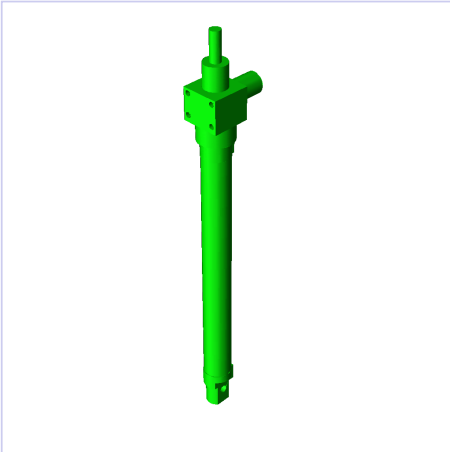

dsnu_25_200_p_a_kp.prt
100.00 %



dsnu_25_200_p_a_kp.stp
100.00 %



dsnu_25_200_p_pv_a_kp.prt
100.00 %

Name

46. [dsnu_25_200_ppv_a_kp.prt](#) (4 members)

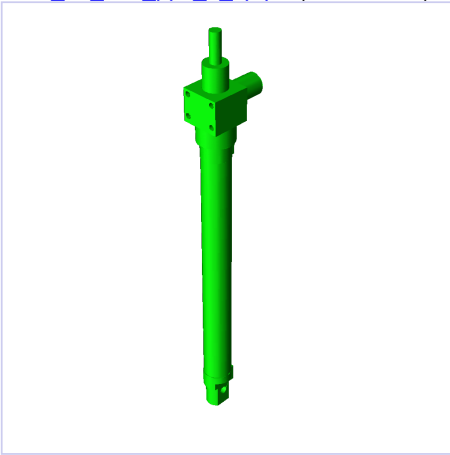

Similar parts



dsnu_25_200_p
_a_kp.prt
100.00 %



dsnu_25_200_p
_a_kp.stp
100.00 %



dsnu_25_200_p
pv_a_kp.stp
100.00 %

47. [dsnu_25_200_p_a_kp.stp](#) (4 members)

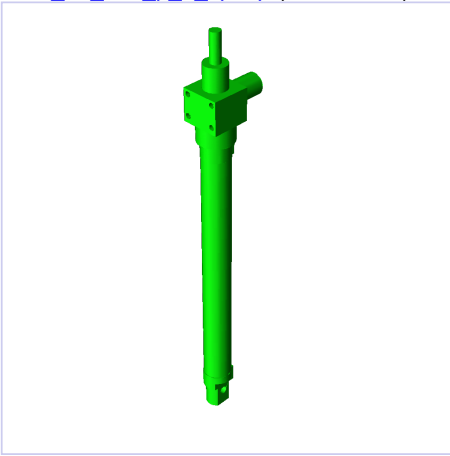

dsnu_25_200_p
_a_kp.prt
100.00 %



dsnu_25_200_p
pv_a_kp.prt
100.00 %



dsnu_25_200_p
pv_a_kp.stp
100.00 %

48. [dsnu_25_200_p_a_kp.prt](#) (4 members)

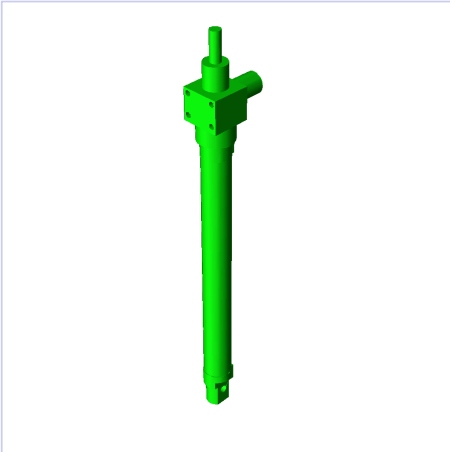

dsnu_25_200_p
_a_kp.stp
100.00 %



dsnu_25_200_p
pv_a_kp.prt
100.00 %



dsnu_25_200_p
pv_a_kp.stp
100.00 %

Name

49. [dsnu_25_125_ppv_a_kp.stp](#) (4 members)

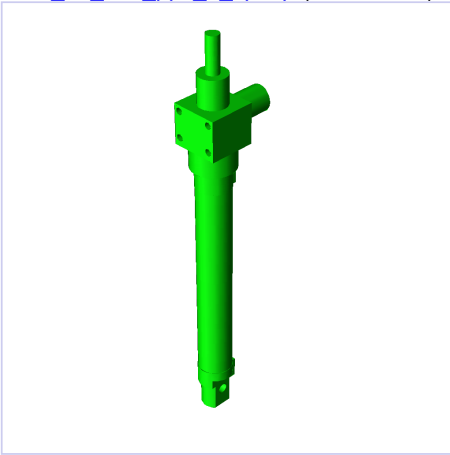

Similar parts



dsnu_25_125_p
_a_kp.prt
100.00 %



dsnu_25_125_p
_a_kp.stp
100.00 %



dsnu_25_125_p
pv_a_kp.prt
100.00 %

50. [dsnu_25_125_ppv_a_kp.prt](#) (4 members)

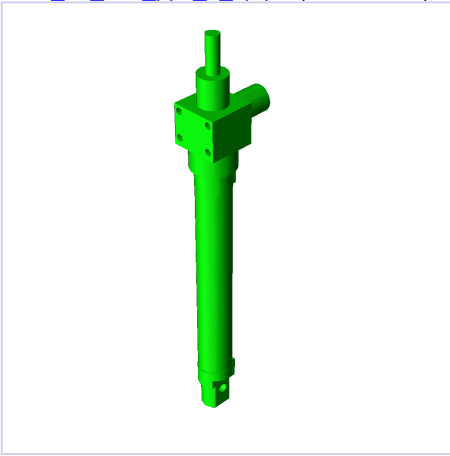

dsnu_25_125_p
_a_kp.prt
100.00 %



dsnu_25_125_p
_a_kp.stp
100.00 %



dsnu_25_125_p
pv_a_kp.stp
100.00 %

Shape Analytics of different-named models in dataset [redacted] with 85.00 % cutoff (11406 groups equivalent to 30015 pairs of matches)

The left column displays each model in the dataset [redacted] that has one or more matching parts in the same dataset. The right column displays each of these matching parts. Each entry in the right column has a score between 0% and 100%, where 100% indicates an exact geometric match.

Results per page: Go to page:

Page: [prev](#) | [1](#) | ... | [5](#) | [6](#) | [7](#) | [8](#) | [9](#) | [10](#) | [11](#) | [12](#) | [13](#) | [14](#) | [15](#) | ... | [229](#) | [next](#)

[Name](#)

[Similar parts](#)

451. [540565_vuvy_l_m52_ah_g14_8ac1.stp](#) (12 members)

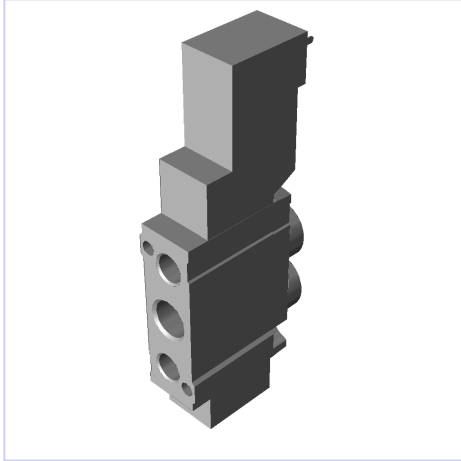

[540561_vuvy_l_m52_ah_g14_1c1.stp](#)
100.00 %

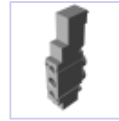

[540562_vuvy_l_m52_ah_g14_2ac1.stp](#)
100.00 %

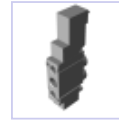

[540563_vuvy_l_m52_ah_g14_3ac1.stp](#)
100.00 %

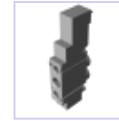

[540564_vuvy_l_m52_ah_g14_5c1.stp](#)
100.00 %

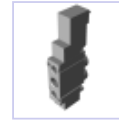

[540566_vuvy_l_m52_ah_g14_9ac1.stp](#)
100.00 %

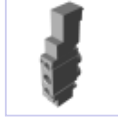

[540561_vuvy_l_m52_ah_g14_1c1.sat](#)
99.89 %



[540562_vuvy_l_m52_ah_g14_2ac1.sat](#)
99.89 %

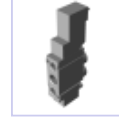

[540563_vuvy_l_m52_ah_g14_3ac1.sat](#)
99.89 %

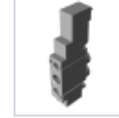

[540564_vuvy_l_m52_ah_g14_5c1.sat](#)
99.89 %

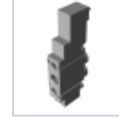

[540565_vuvy_l_m52_ah_g14_8ac1.sat](#)
99.89 %

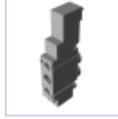

[540566_vuvy_l_m52_ah_g14_9ac1.sat](#)
99.89 %

452. [540565_vuvy_l_m52_ah_g14_8ac1.sat](#) (12 members)

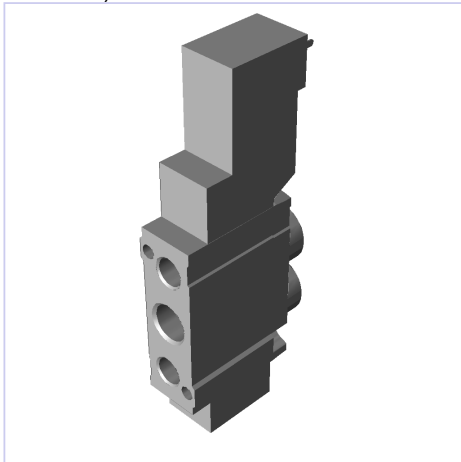

[540561_vuvy_l_m52_ah_g14_1c1.sat](#)
100.00 %

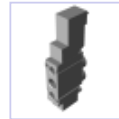

[540562_vuvy_l_m52_ah_g14_2ac1.sat](#)
100.00 %

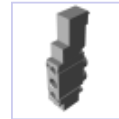

[540563_vuvy_l_m52_ah_g14_3ac1.sat](#)
100.00 %

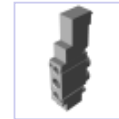

[540564_vuvy_l_m52_ah_g14_5c1.sat](#)
100.00 %

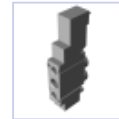

[540566_vuvy_l_m52_ah_g14_9ac1.sat](#)
100.00 %



[540561_vuvy_l_m52_ah_g14_1c1.stp](#)
99.89 %

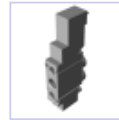

[540562_vuvy_l_m52_ah_g14_2ac1.stp](#)
99.89 %

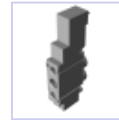

[540563_vuvy_l_m52_ah_g14_3ac1.stp](#)
99.89 %

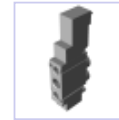

[540564_vuvy_l_m52_ah_g14_5c1.stp](#)
99.89 %



[540565_vuvy_l_m52_ah_g14_8ac1.stp](#)
99.89 %



[540566_vuvy_l_m52_ah_g14_9ac1.stp](#)
99.89 %

Name

453. [540564_vuvy_l_m52_ah_g14_5c1.stp](#) (12 members)

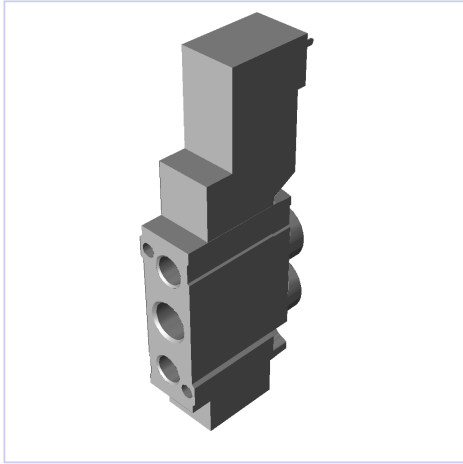

Similar parts

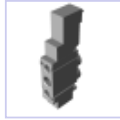

540561_vuvy_l_m52_ah_g14_1c1.stp
100.00 %



540562_vuvy_l_m52_ah_g14_2ac1.stp
100.00 %



540563_vuvy_l_m52_ah_g14_3ac1.stp
100.00 %



540565_vuvy_l_m52_ah_g14_8ac1.stp
100.00 %

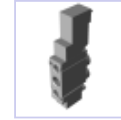

540566_vuvy_l_m52_ah_g14_9ac1.stp
100.00 %



540561_vuvy_l_m52_ah_g14_1c1.sat
99.89 %

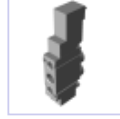

540562_vuvy_l_m52_ah_g14_2ac1.sat
99.89 %

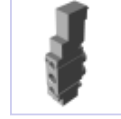

540563_vuvy_l_m52_ah_g14_3ac1.sat
99.89 %

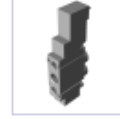

540564_vuvy_l_m52_ah_g14_5c1.sat
99.89 %



540565_vuvy_l_m52_ah_g14_8ac1.sat
99.89 %

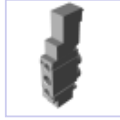

540566_vuvy_l_m52_ah_g14_9ac1.sat
99.89 %

454. [540564_vuvy_l_m52_ah_g14_5c1.sat](#) (12 members)

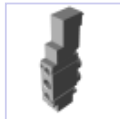
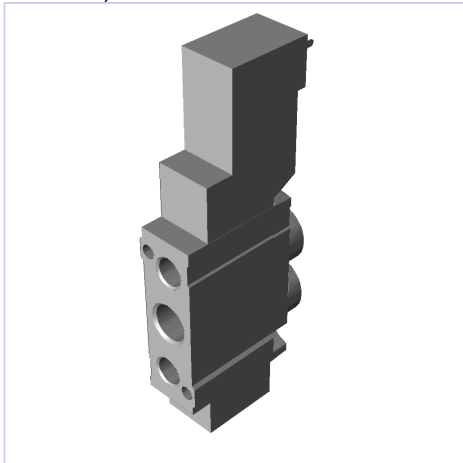

540561_vuvy_l_m52_ah_g14_1c1.sat
100.00 %

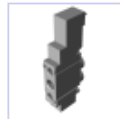

540562_vuvy_l_m52_ah_g14_2ac1.sat
100.00 %

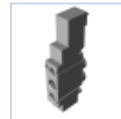

540563_vuvy_l_m52_ah_g14_3ac1.sat
100.00 %

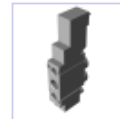

540565_vuvy_l_m52_ah_g14_8ac1.sat
100.00 %

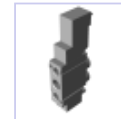

540566_vuvy_l_m52_ah_g14_9ac1.sat
100.00 %

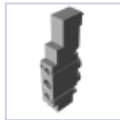

540561_vuvy_l_m52_ah_g14_1c1.stp
99.89 %

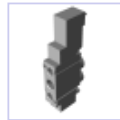

540562_vuvy_l_m52_ah_g14_2ac1.stp
99.89 %

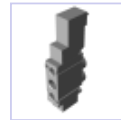

540563_vuvy_l_m52_ah_g14_3ac1.stp
99.89 %



540564_vuvy_l_m52_ah_g14_5c1.stp
99.89 %

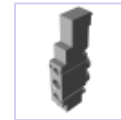

540565_vuvy_l_m52_ah_g14_8ac1.stp
99.89 %

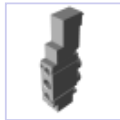

540566_vuvy_l_m52_ah_g14_9ac1.stp
99.89 %

Name

455. 540563_vuvy_l_m52_ah_g14_3ac1.stp (12 members)

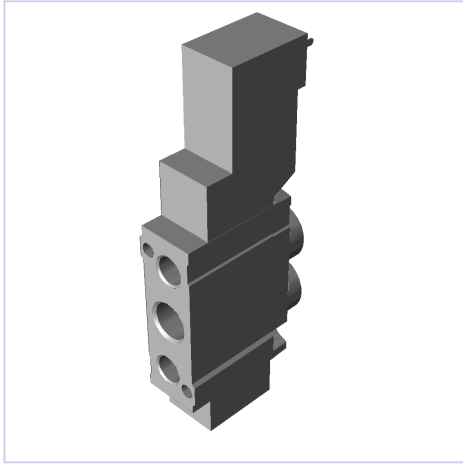

Similar parts

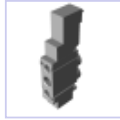

540561_vuvy_l_m52_ah_g14_1c1.stp
100.00 %



540562_vuvy_l_m52_ah_g14_2ac1.stp
100.00 %



540564_vuvy_l_m52_ah_g14_5c1.stp
100.00 %

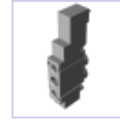

540565_vuvy_l_m52_ah_g14_8ac1.stp
100.00 %

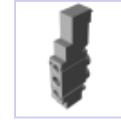

540566_vuvy_l_m52_ah_g14_9ac1.stp
100.00 %

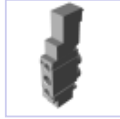

540561_vuvy_l_m52_ah_g14_1c1.sat
99.89 %

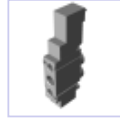

540562_vuvy_l_m52_ah_g14_2ac1.sat
99.89 %



540563_vuvy_l_m52_ah_g14_3ac1.sat
99.89 %

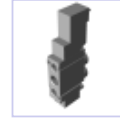

540564_vuvy_l_m52_ah_g14_5c1.sat
99.89 %

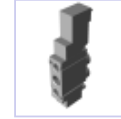

540565_vuvy_l_m52_ah_g14_8ac1.sat
99.89 %

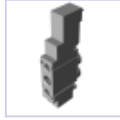

540566_vuvy_l_m52_ah_g14_9ac1.sat
99.89 %

456. 540563_vuvy_l_m52_ah_g14_3ac1.sat (12 members)

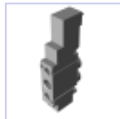
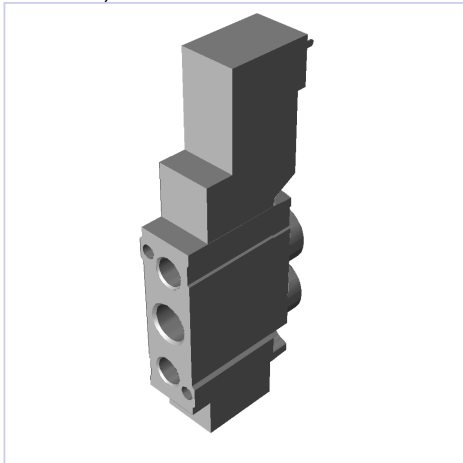

540561_vuvy_l_m52_ah_g14_1c1.sat
100.00 %

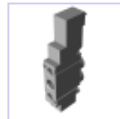

540562_vuvy_l_m52_ah_g14_2ac1.sat
100.00 %

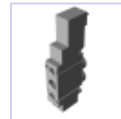

540564_vuvy_l_m52_ah_g14_5c1.sat
100.00 %

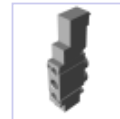

540565_vuvy_l_m52_ah_g14_8ac1.sat
100.00 %

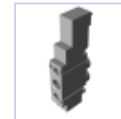

540566_vuvy_l_m52_ah_g14_9ac1.sat
100.00 %



540561_vuvy_l_m52_ah_g14_1c1.stp
99.89 %

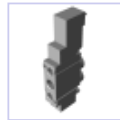

540562_vuvy_l_m52_ah_g14_2ac1.stp
99.89 %

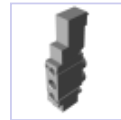

540563_vuvy_l_m52_ah_g14_3ac1.sat
99.89 %

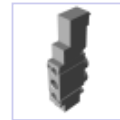

540564_vuvy_l_m52_ah_g14_5c1.sat
99.89 %

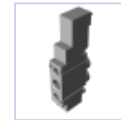

540565_vuvy_l_m52_ah_g14_8ac1.sat
99.89 %

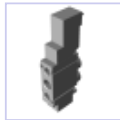

540566_vuvy_l_m52_ah_g14_9ac1.sat
99.89 %

Name

457. 540562_vuvy_l_m52_ah_g14_2ac1.stp (12 members)

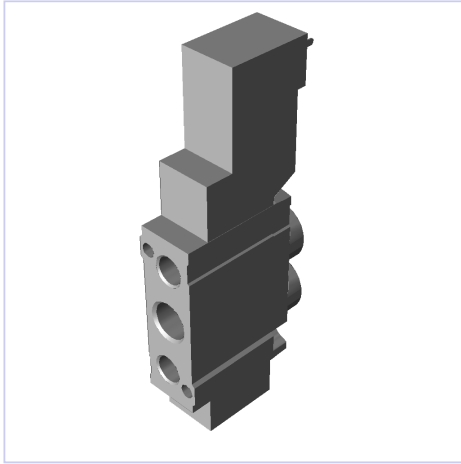

Similar parts

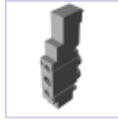

540561_vuvy_l_m52_ah_g14_1c1.stp
100.00 %



540563_vuvy_l_m52_ah_g14_3ac1.stp
100.00 %

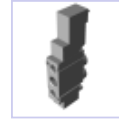

540564_vuvy_l_m52_ah_g14_5c1.stp
100.00 %

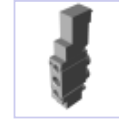

540565_vuvy_l_m52_ah_g14_8ac1.stp
100.00 %

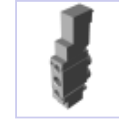

540566_vuvy_l_m52_ah_g14_9ac1.stp
100.00 %

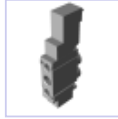

540561_vuvy_l_m52_ah_g14_1c1.sat
99.89 %



540562_vuvy_l_m52_ah_g14_2ac1.sat
99.89 %

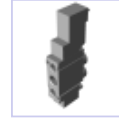

540563_vuvy_l_m52_ah_g14_3ac1.sat
99.89 %

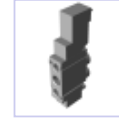

540564_vuvy_l_m52_ah_g14_5c1.sat
99.89 %

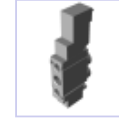

540565_vuvy_l_m52_ah_g14_8ac1.sat
99.89 %



540566_vuvy_l_m52_ah_g14_9ac1.sat
99.89 %

458. 540562_vuvy_l_m52_ah_g14_2ac1.sat (12 members)

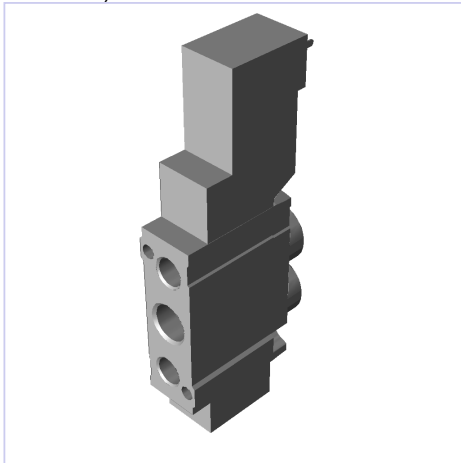

540561_vuvy_l_m52_ah_g14_1c1.sat
100.00 %

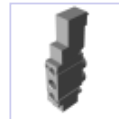

540563_vuvy_l_m52_ah_g14_3ac1.sat
100.00 %

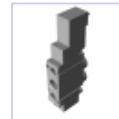

540564_vuvy_l_m52_ah_g14_5c1.sat
100.00 %

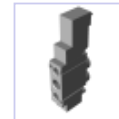

540565_vuvy_l_m52_ah_g14_8ac1.sat
100.00 %

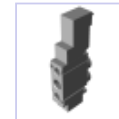

540566_vuvy_l_m52_ah_g14_9ac1.sat
100.00 %



540561_vuvy_l_m52_ah_g14_1c1.stp
99.89 %

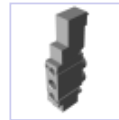

540562_vuvy_l_m52_ah_g14_2ac1.stp
99.89 %

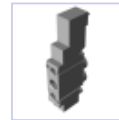

540563_vuvy_l_m52_ah_g14_3ac1.stp
99.89 %

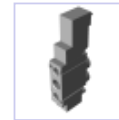

540564_vuvy_l_m52_ah_g14_5c1.stp
99.89 %

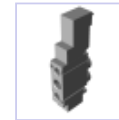

540565_vuvy_l_m52_ah_g14_8ac1.stp
99.89 %



540566_vuvy_l_m52_ah_g14_9ac1.stp
99.89 %

Name

459. 540561_vuvy_l_m52_ah_g14_1c1.stp (12 members)

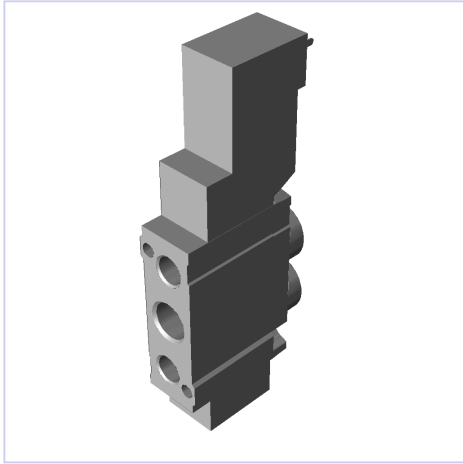

Similar parts

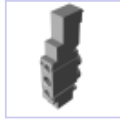

540562_vuvy_l_m52_ah_g14_2ac1.stp
100.00 %



540563_vuvy_l_m52_ah_g14_3ac1.stp
100.00 %



540564_vuvy_l_m52_ah_g14_5c1.stp
100.00 %



540565_vuvy_l_m52_ah_g14_8ac1.stp
100.00 %

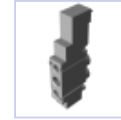

540566_vuvy_l_m52_ah_g14_9ac1.stp
100.00 %

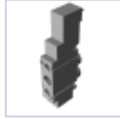

540561_vuvy_l_m52_ah_g14_1c1.sat
99.89 %

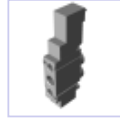

540562_vuvy_l_m52_ah_g14_2ac1.sat
99.89 %

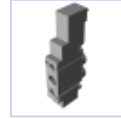

540563_vuvy_l_m52_ah_g14_3ac1.sat
99.89 %

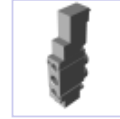

540564_vuvy_l_m52_ah_g14_5c1.sat
99.89 %

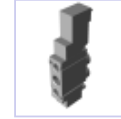

540565_vuvy_l_m52_ah_g14_8ac1.sat
99.89 %

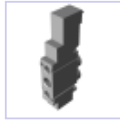

540566_vuvy_l_m52_ah_g14_9ac1.sat
99.89 %

460. 540561_vuvy_l_m52_ah_g14_1c1.sat (12 members)

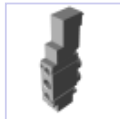
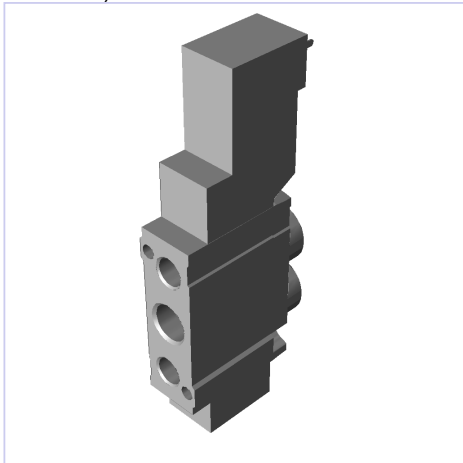

540562_vuvy_l_m52_ah_g14_2ac1.sat
100.00 %

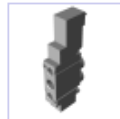

540563_vuvy_l_m52_ah_g14_3ac1.sat
100.00 %

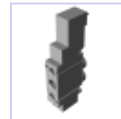

540564_vuvy_l_m52_ah_g14_5c1.sat
100.00 %

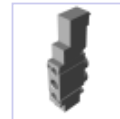

540565_vuvy_l_m52_ah_g14_8ac1.sat
100.00 %

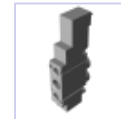

540566_vuvy_l_m52_ah_g14_9ac1.sat
100.00 %



540561_vuvy_l_m52_ah_g14_1c1.stp
99.89 %

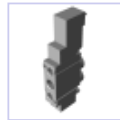

540562_vuvy_l_m52_ah_g14_2ac1.stp
99.89 %

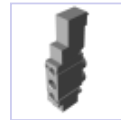

540563_vuvy_l_m52_ah_g14_3ac1.stp
99.89 %



540564_vuvy_l_m52_ah_g14_5c1.stp
99.89 %

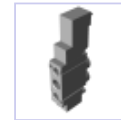

540565_vuvy_l_m52_ah_g14_8ac1.stp
99.89 %

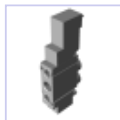

540566_vuvy_l_m52_ah_g14_9ac1.stp
99.89 %

Name

461. [feng_063_400_kf.igs](#) (6 members)

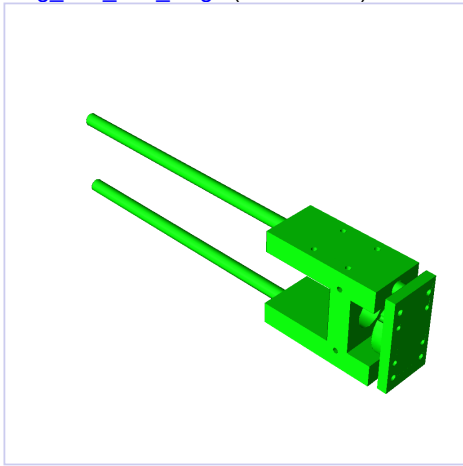

Similar parts



feng_063_400.igs
100.00 %



feng_063_400.prt
100.00 %



feng_063_400_kf.prt
100.00 %



feng_063_400.stp
99.85 %



feng_063_400_kf.stp
99.85 %

462. [feng_063_400.igs](#) (6 members)

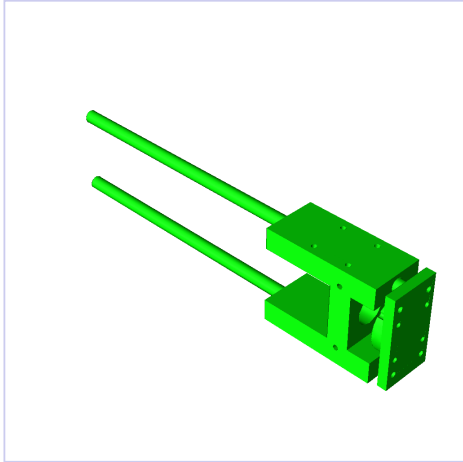

feng_063_400.prt
100.00 %



feng_063_400_kf.igs
100.00 %



feng_063_400_kf.prt
100.00 %



feng_063_400.stp
99.85 %

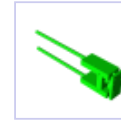

feng_063_400_kf.stp
99.85 %

463. [dsn_25_400_ppv_s2.igs](#) (9 members)

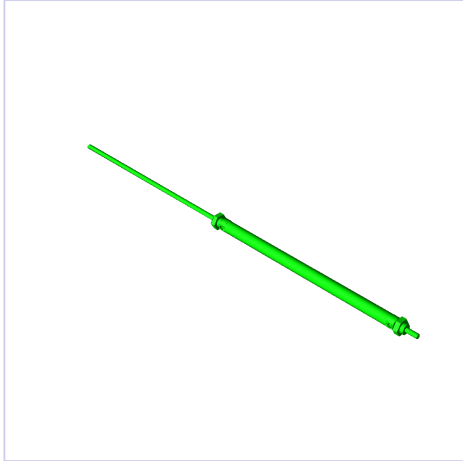

dsn_25_400_ppv_s2.stp
100.00 %



dsn_25_400_ppv_s2.stp
100.00 %



dsnu_25_400_ppv_a_S2.stp
100.00 %



dsnu_25_400_ppv_a_s2.stp
100.00 %



dsn_25_400_ppv_s2.prt
99.88 %



dsn_25_400_ppv_s2.prt
99.88 %



dsnu_25_400_ppv_a_s2.prt
99.88 %



dsnu_25_400_ppv_a_s2.prt
99.88 %

Name

464. [feng_100_500_kf.prt](#) (6 members)

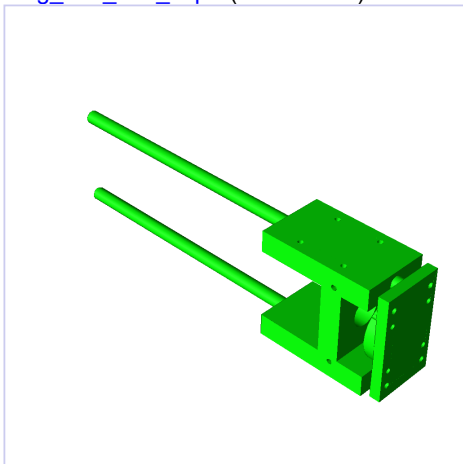

Similar parts



feng_100_500.igs
100.00 %



feng_100_500.prt
100.00 %



feng_100_500_kf.igs
100.00 %



feng_100_500.stp
99.85 %



feng_100_500_kf.stp
99.85 %

465. [feng_100_500.prt](#) (6 members)

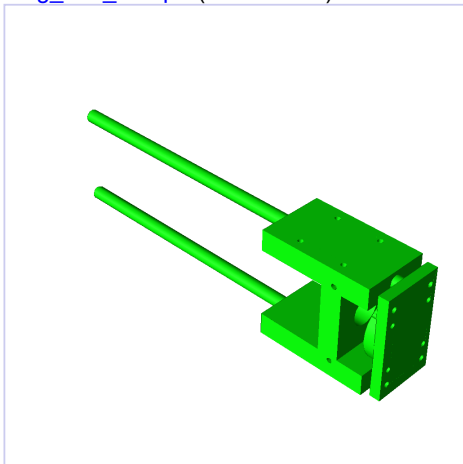

feng_100_500.igs
100.00 %

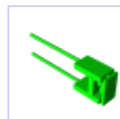

feng_100_500_kf.igs
100.00 %



feng_100_500_kf.prt
100.00 %

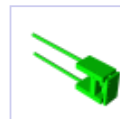

feng_100_500.stp
99.85 %



feng_100_500_kf.stp
99.85 %

466. [dsnu_25_160_ppv_a_s2.stp](#) (9 members)

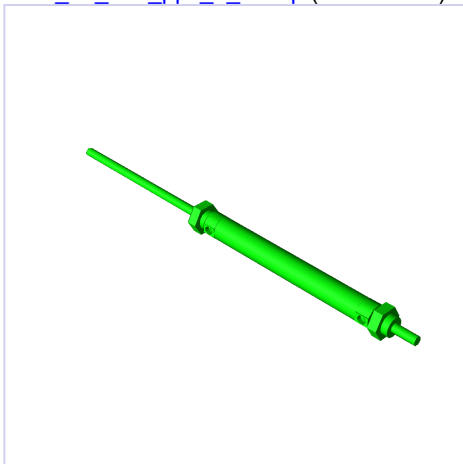

dsn_25_160_ppv_s2.prt
100.00 %



dsn_25_160_ppv_s2.stp
100.00 %



dsn_25_160_ppv_s2.prt
100.00 %



dsn_25_160_ppv_s2.stp
100.00 %



dsnu_25_160_ppv_a_s2.prt
100.00 %



dsnu_25_160_ppv_a_S2.stp
100.00 %



dsnu_25_160_ppv_a_s2.prt
100.00 %



dsn_25_160_ppv_s2.igs
99.50 %

Name

467. [dsnu_25_160_p_a_S2.stp](#) (9 members)

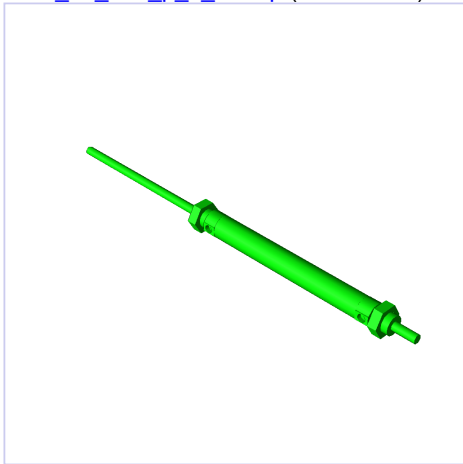

Similar parts



dsn_25_160_p_s2.prt
100.00 %



dsn_25_160_p_s2.stp
100.00 %



dsn_25_160_pp_v_s2.prt
100.00 %



dsn_25_160_pp_v_s2.stp
100.00 %

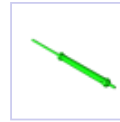

dsnu_25_160_p_a_s2.prt
100.00 %



dsnu_25_160_pv_a_s2.prt
100.00 %



dsnu_25_160_pv_a_s2.stp
100.00 %



dsn_25_160_pp_v_s2.igs
99.50 %

468. [dsn_25_160_ppv_s2.stp](#) (9 members)

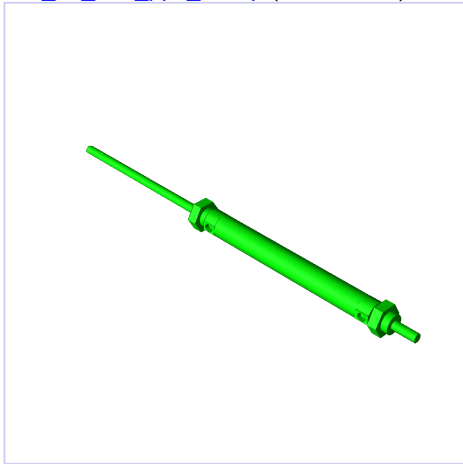

dsn_25_160_p_s2.prt
100.00 %



dsn_25_160_p_s2.stp
100.00 %

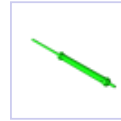

dsn_25_160_pp_v_s2.prt
100.00 %



dsnu_25_160_p_a_s2.prt
100.00 %



dsnu_25_160_p_a_S2.stp
100.00 %



dsnu_25_160_pv_a_s2.prt
100.00 %



dsnu_25_160_pv_a_s2.stp
100.00 %



dsn_25_160_pp_v_s2.igs
99.50 %

469. [dsn_25_160_p_s2.stp](#) (9 members)

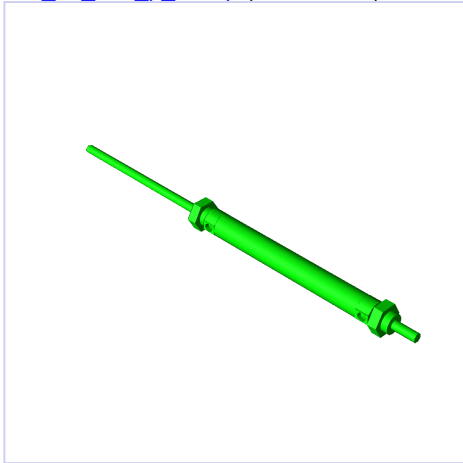

dsn_25_160_p_s2.prt
100.00 %



dsn_25_160_pp_v_s2.prt
100.00 %



dsn_25_160_pp_v_s2.stp
100.00 %



dsnu_25_160_p_a_s2.prt
100.00 %



dsnu_25_160_p_a_S2.stp
100.00 %



dsnu_25_160_pv_a_s2.prt
100.00 %



dsnu_25_160_pv_a_s2.stp
100.00 %



dsn_25_160_pp_v_s2.igs
99.50 %

Name

470. 540584_vuvy_l_p53u_h_g14_9ac1.stp (36 members)

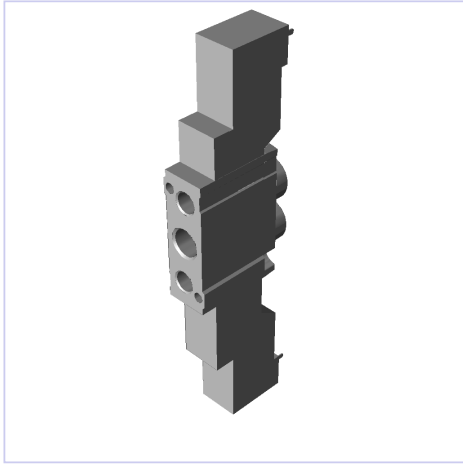

Similar parts

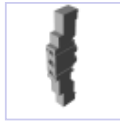

540567_vuvy_l_p53c_h_g14_1c1.stp
100.00 %



540568_vuvy_l_p53c_h_g14_2ac1.stp
100.00 %

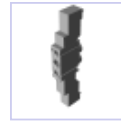

540569_vuvy_l_p53c_h_g14_3ac1.stp
100.00 %

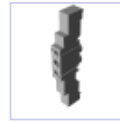

540570_vuvy_l_p53c_h_g14_5c1.stp
100.00 %

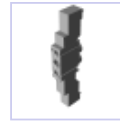

540571_vuvy_l_p53c_h_g14_8ac1.stp
100.00 %

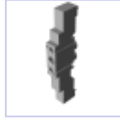

540572_vuvy_l_p53c_h_g14_9ac1.stp
100.00 %



540573_vuvy_l_p53e_h_g14_1c1.stp
100.00 %



540574_vuvy_l_p53e_h_g14_2ac1.stp
100.00 %



540575_vuvy_l_p53e_h_g14_3ac1.stp
100.00 %



540576_vuvy_l_p53e_h_g14_5c1.stp
100.00 %



540577_vuvy_l_p53e_h_g14_8ac1.stp
100.00 %



540578_vuvy_l_p53e_h_g14_9ac1.stp
100.00 %



540579_vuvy_l_p53u_h_g14_1c1.stp
100.00 %



540580_vuvy_l_p53u_h_g14_2ac1.stp
100.00 %



540581_vuvy_l_p53u_h_g14_3ac1.stp
100.00 %

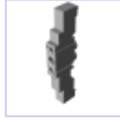

540582_vuvy_l_p53u_h_g14_5c1.stp
100.00 %



540583_vuvy_l_p53u_h_g14_8ac1.stp
100.00 %

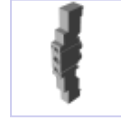

540567_vuvy_l_p53c_h_g14_1c1.sat
99.88 %

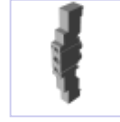

540568_vuvy_l_p53c_h_g14_2ac1.sat
99.88 %



540569_vuvy_l_p53c_h_g14_3ac1.sat
99.88 %

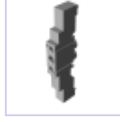

540570_vuvy_l_p53c_h_g14_5c1.sat
99.88 %

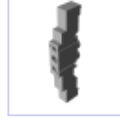

540571_vuvy_l_p53c_h_g14_8ac1.sat
99.88 %

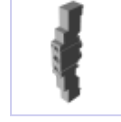

540572_vuvy_l_p53c_h_g14_9ac1.sat
99.88 %

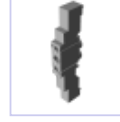

540573_vuvy_l_p53e_h_g14_1c1.sat
99.88 %

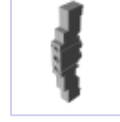

540574_vuvy_l_p53e_h_g14_2ac1.sat
99.88 %



540575_vuvy_l_p53e_h_g14_3ac1.sat
99.88 %



540576_vuvy_l_p53e_h_g14_5c1.sat
99.88 %

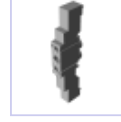

540577_vuvy_l_p53e_h_g14_8ac1.sat
99.88 %

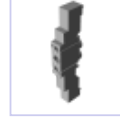

540578_vuvy_l_p53e_h_g14_9ac1.sat
99.88 %



540579_vuvy_l_p53u_h_g14_1c1.sat
99.88 %

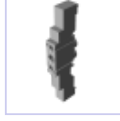

540580_vuvy_l_p53u_h_g14_2ac1.sat
99.88 %



540581_vuvy_l_p53u_h_g14_3ac1.sat
99.88 %



540582_vuvy_l_p53u_h_g14_5c1.sat
99.88 %

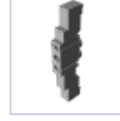

540583_vuvy_l_p53u_h_g14_8ac1.sat
99.88 %

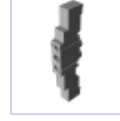

540584_vuvy_l_p53u_h_g14_9ac1.sat
99.88 %

Name

471. 540584_vuvy_l_p53u_h_g14_9ac1.sat (36 members)

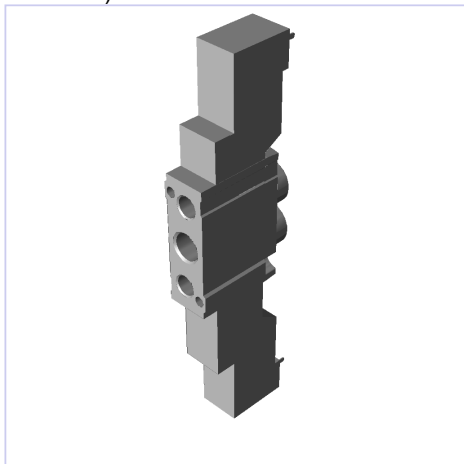

Similar parts

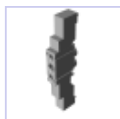

540567_vuvy_l_p53c_h_g14_1c1.sat

100.00 %

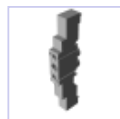

540568_vuvy_l_p53c_h_g14_2ac1.sat

100.00 %

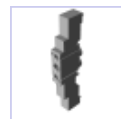

540569_vuvy_l_p53c_h_g14_3ac1.sat

100.00 %

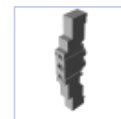

540570_vuvy_l_p53c_h_g14_5c1.sat

100.00 %

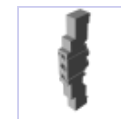

540571_vuvy_l_p53c_h_g14_8ac1.sat

100.00 %

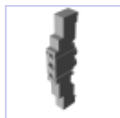

540572_vuvy_l_p53c_h_g14_9ac1.sat

100.00 %

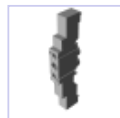

540573_vuvy_l_p53e_h_g14_1c1.sat

100.00 %

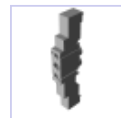

540574_vuvy_l_p53e_h_g14_2ac1.sat

100.00 %

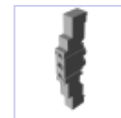

540575_vuvy_l_p53e_h_g14_3ac1.sat

100.00 %

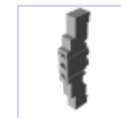

540576_vuvy_l_p53e_h_g14_5c1.sat

100.00 %

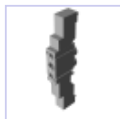

540577_vuvy_l_p53e_h_g14_8ac1.sat

100.00 %

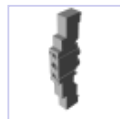

540578_vuvy_l_p53e_h_g14_9ac1.sat

100.00 %

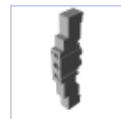

540579_vuvy_l_p53u_h_g14_1c1.sat

100.00 %

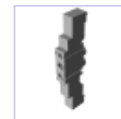

540580_vuvy_l_p53u_h_g14_2ac1.sat

100.00 %

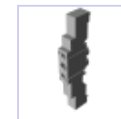

540581_vuvy_l_p53u_h_g14_3ac1.sat

100.00 %

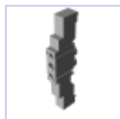

540582_vuvy_l_p53u_h_g14_5c1.sat

100.00 %

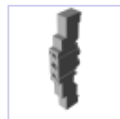

540583_vuvy_l_p53u_h_g14_8ac1.sat

100.00 %

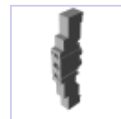

540567_vuvy_l_p53c_h_g14_1c1.stp

99.88 %

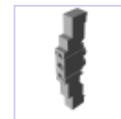

540568_vuvy_l_p53c_h_g14_2ac1.stp

99.88 %

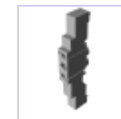

540569_vuvy_l_p53c_h_g14_3ac1.stp

99.88 %

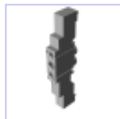

540570_vuvy_l_p53c_h_g14_5c1.stp

99.88 %

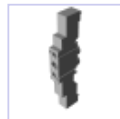

540571_vuvy_l_p53c_h_g14_8ac1.stp

99.88 %

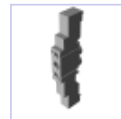

540572_vuvy_l_p53c_h_g14_9ac1.stp

99.88 %

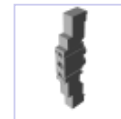

540573_vuvy_l_p53e_h_g14_1c1.stp

99.88 %

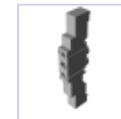

540574_vuvy_l_p53e_h_g14_2ac1.stp

99.88 %

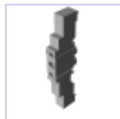

540575_vuvy_l_p53e_h_g14_3ac1.stp

99.88 %

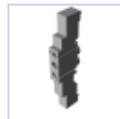

540576_vuvy_l_p53e_h_g14_5c1.stp

99.88 %

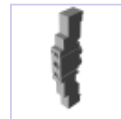

540577_vuvy_l_p53e_h_g14_8ac1.stp

99.88 %

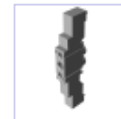

540578_vuvy_l_p53e_h_g14_9ac1.stp

99.88 %

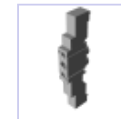

540579_vuvy_l_p53u_h_g14_1c1.stp

99.88 %

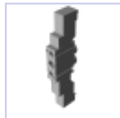

540580_vuvy_l_p53u_h_g14_2ac1.stp

99.88 %

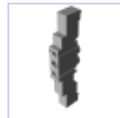

540581_vuvy_l_p53u_h_g14_3ac1.stp

99.88 %

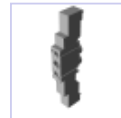

540582_vuvy_l_p53u_h_g14_5c1.stp

99.88 %

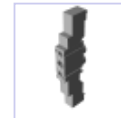

540583_vuvy_l_p53u_h_g14_8ac1.stp

99.88 %

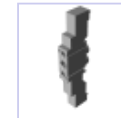

540584_vuvy_l_p53u_h_g14_9ac1.stp

99.88 %

Name

472. 540583_vuvy_l_p53u_h_g14_8ac1.stp (36 members)

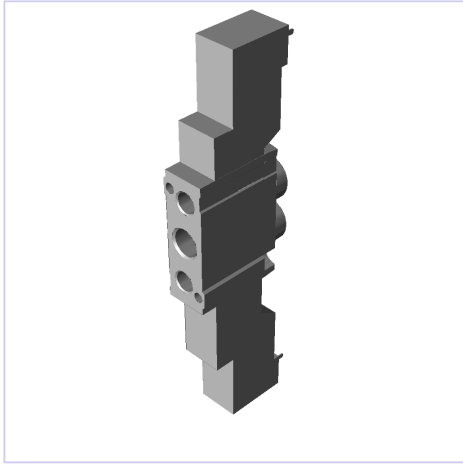

Similar parts



540567_vuvy_l_p53c_h_g14_1c1.stp
100.00 %



540568_vuvy_l_p53c_h_g14_2ac1.stp
100.00 %



540569_vuvy_l_p53c_h_g14_3ac1.stp
100.00 %



540570_vuvy_l_p53c_h_g14_5c1.stp
100.00 %



540571_vuvy_l_p53c_h_g14_8ac1.stp
100.00 %

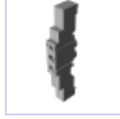

540572_vuvy_l_p53c_h_g14_9ac1.stp
100.00 %



540573_vuvy_l_p53e_h_g14_1c1.stp
100.00 %



540574_vuvy_l_p53e_h_g14_2ac1.stp
100.00 %



540575_vuvy_l_p53e_h_g14_3ac1.stp
100.00 %



540576_vuvy_l_p53e_h_g14_5c1.stp
100.00 %

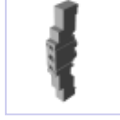

540577_vuvy_l_p53e_h_g14_8ac1.stp
100.00 %

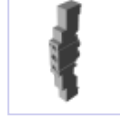

540578_vuvy_l_p53e_h_g14_9ac1.stp
100.00 %

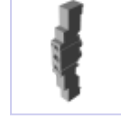

540579_vuvy_l_p53u_h_g14_1c1.stp
100.00 %

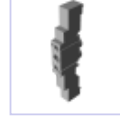

540580_vuvy_l_p53u_h_g14_2ac1.stp
100.00 %



540581_vuvy_l_p53u_h_g14_3ac1.stp
100.00 %



540582_vuvy_l_p53u_h_g14_5c1.stp
100.00 %



540584_vuvy_l_p53u_h_g14_9ac1.stp
100.00 %

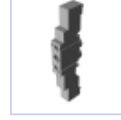

540567_vuvy_l_p53c_h_g14_1c1.sat
99.88 %



540568_vuvy_l_p53c_h_g14_2ac1.sat
99.88 %

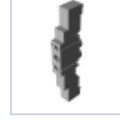

540569_vuvy_l_p53c_h_g14_3ac1.sat
99.88 %



540570_vuvy_l_p53c_h_g14_5c1.sat
99.88 %

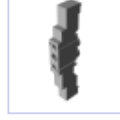

540571_vuvy_l_p53c_h_g14_8ac1.sat
99.88 %



540572_vuvy_l_p53c_h_g14_9ac1.sat
99.88 %



540573_vuvy_l_p53e_h_g14_1c1.sat
99.88 %



540574_vuvy_l_p53e_h_g14_2ac1.sat
99.88 %



540575_vuvy_l_p53e_h_g14_3ac1.sat
99.88 %



540576_vuvy_l_p53e_h_g14_5c1.sat
99.88 %



540577_vuvy_l_p53e_h_g14_8ac1.sat
99.88 %



540578_vuvy_l_p53e_h_g14_9ac1.sat
99.88 %



540579_vuvy_l_p53u_h_g14_1c1.sat
99.88 %



540580_vuvy_l_p53u_h_g14_2ac1.sat
99.88 %



540581_vuvy_l_p53u_h_g14_3ac1.sat
99.88 %



540582_vuvy_l_p53u_h_g14_5c1.sat
99.88 %



540583_vuvy_l_p53u_h_g14_8ac1.sat
99.88 %



540584_vuvy_l_p53u_h_g14_9ac1.sat
99.88 %

Name

473. 540583_vuvy_l_p53u_h_g14_8ac1.sat (36 members)

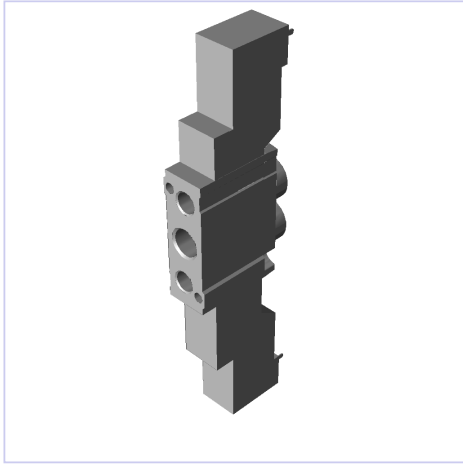

Similar parts



540567_vuvy_l_p53c_h_g14_1c1.sat
100.00 %

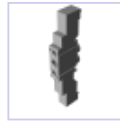

540568_vuvy_l_p53c_h_g14_2ac1.sat
100.00 %

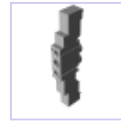

540569_vuvy_l_p53c_h_g14_3ac1.sat
100.00 %

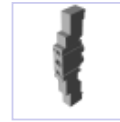

540570_vuvy_l_p53c_h_g14_5c1.sat
100.00 %



540571_vuvy_l_p53c_h_g14_8ac1.sat
100.00 %



540572_vuvy_l_p53c_h_g14_9ac1.sat
100.00 %



540573_vuvy_l_p53e_h_g14_1c1.sat
100.00 %

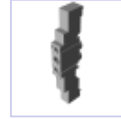

540574_vuvy_l_p53e_h_g14_2ac1.sat
100.00 %



540575_vuvy_l_p53e_h_g14_3ac1.sat
100.00 %



540576_vuvy_l_p53e_h_g14_5c1.sat
100.00 %

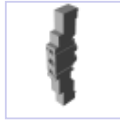

540577_vuvy_l_p53e_h_g14_8ac1.sat
100.00 %



540578_vuvy_l_p53e_h_g14_9ac1.sat
100.00 %

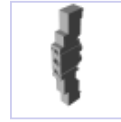

540579_vuvy_l_p53u_h_g14_1c1.sat
100.00 %



540580_vuvy_l_p53u_h_g14_2ac1.sat
100.00 %



540581_vuvy_l_p53u_h_g14_3ac1.sat
100.00 %

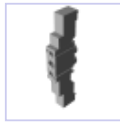

540582_vuvy_l_p53u_h_g14_5c1.sat
100.00 %



540584_vuvy_l_p53u_h_g14_9ac1.sat
100.00 %

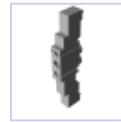

540567_vuvy_l_p53c_h_g14_1c1.stp
99.88 %

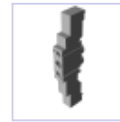

540568_vuvy_l_p53c_h_g14_2ac1.stp
99.88 %



540569_vuvy_l_p53c_h_g14_3ac1.stp
99.88 %

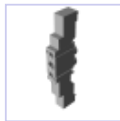

540570_vuvy_l_p53c_h_g14_5c1.stp
99.88 %

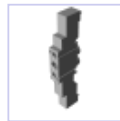

540571_vuvy_l_p53c_h_g14_8ac1.stp
99.88 %

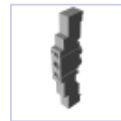

540572_vuvy_l_p53c_h_g14_9ac1.stp
99.88 %

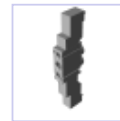

540573_vuvy_l_p53e_h_g14_1c1.stp
99.88 %

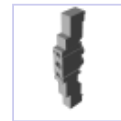

540574_vuvy_l_p53e_h_g14_2ac1.stp
99.88 %

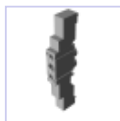

540575_vuvy_l_p53e_h_g14_3ac1.stp
99.88 %

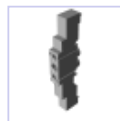

540576_vuvy_l_p53e_h_g14_5c1.stp
99.88 %

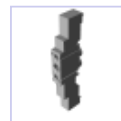

540577_vuvy_l_p53e_h_g14_8ac1.stp
99.88 %

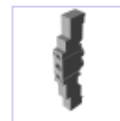

540578_vuvy_l_p53e_h_g14_9ac1.stp
99.88 %

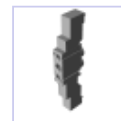

540579_vuvy_l_p53u_h_g14_1c1.stp
99.88 %

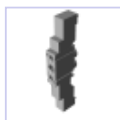

540580_vuvy_l_p53u_h_g14_2ac1.stp
99.88 %

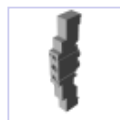

540581_vuvy_l_p53u_h_g14_3ac1.stp
99.88 %

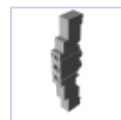

540582_vuvy_l_p53u_h_g14_5c1.stp
99.88 %

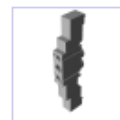

540583_vuvy_l_p53u_h_g14_8ac1.stp
99.88 %

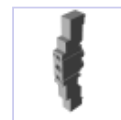

540584_vuvy_l_p53u_h_g14_9ac1.stp
99.88 %

Name

474. 540582_vuvy_l_p53u_h_g14_5c1.stp (36 members)

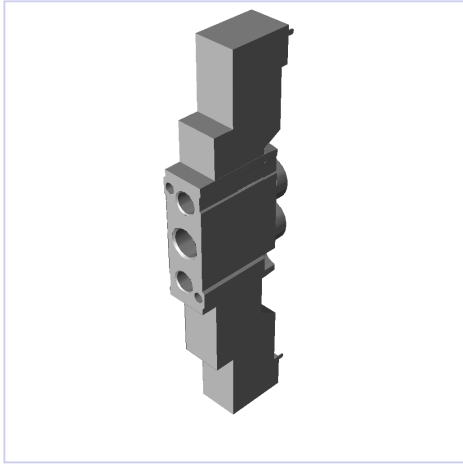

Similar parts



540567_vuvy_l_p53c_h_g14_1c1.stp
100.00 %



540568_vuvy_l_p53c_h_g14_2a1.stp
100.00 %



540569_vuvy_l_p53c_h_g14_3a1.stp
100.00 %



540570_vuvy_l_p53c_h_g14_5c1.stp
100.00 %



540571_vuvy_l_p53c_h_g14_8a1.stp
100.00 %



540572_vuvy_l_p53c_h_g14_9a1.stp
100.00 %



540573_vuvy_l_p53e_h_g14_1c1.stp
100.00 %



540574_vuvy_l_p53e_h_g14_2a1.stp
100.00 %



540575_vuvy_l_p53e_h_g14_3a1.stp
100.00 %



540576_vuvy_l_p53e_h_g14_5c1.stp
100.00 %

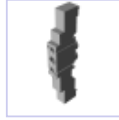

540577_vuvy_l_p53e_h_g14_8a1.stp
100.00 %



540578_vuvy_l_p53e_h_g14_9a1.stp
100.00 %



540579_vuvy_l_p53u_h_g14_1c1.stp
100.00 %



540580_vuvy_l_p53u_h_g14_2a1.stp
100.00 %



540581_vuvy_l_p53u_h_g14_3a1.stp
100.00 %



540583_vuvy_l_p53u_h_g14_8a1.stp
100.00 %

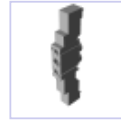

540584_vuvy_l_p53u_h_g14_9a1.stp
100.00 %

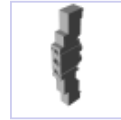

540567_vuvy_l_p53c_h_g14_1c1.sat
99.88 %

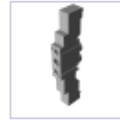

540568_vuvy_l_p53c_h_g14_2a1.sat
99.88 %

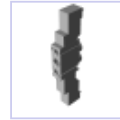

540569_vuvy_l_p53c_h_g14_3a1.sat
99.88 %

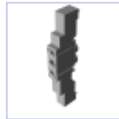

540570_vuvy_l_p53c_h_g14_5c1.sat
99.88 %

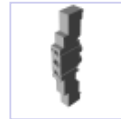

540571_vuvy_l_p53c_h_g14_8a1.sat
99.88 %

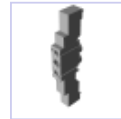

540572_vuvy_l_p53c_h_g14_9a1.sat
99.88 %

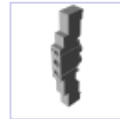

540573_vuvy_l_p53e_h_g14_1c1.sat
99.88 %

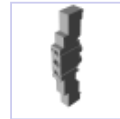

540574_vuvy_l_p53e_h_g14_2a1.sat
99.88 %

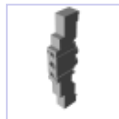

540575_vuvy_l_p53e_h_g14_3a1.sat
99.88 %

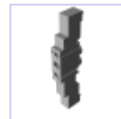

540576_vuvy_l_p53e_h_g14_5c1.sat
99.88 %

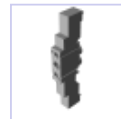

540577_vuvy_l_p53e_h_g14_8a1.sat
99.88 %

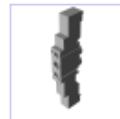

540578_vuvy_l_p53e_h_g14_9a1.sat
99.88 %

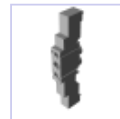

540579_vuvy_l_p53u_h_g14_1c1.sat
99.88 %

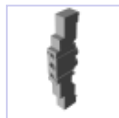

540580_vuvy_l_p53u_h_g14_2a1.sat
99.88 %

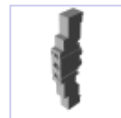

540581_vuvy_l_p53u_h_g14_3a1.sat
99.88 %



540582_vuvy_l_p53u_h_g14_5c1.sat
99.88 %

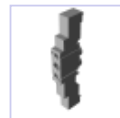

540583_vuvy_l_p53u_h_g14_8a1.sat
99.88 %

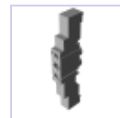

540584_vuvy_l_p53u_h_g14_9a1.sat
99.88 %

Name

475. 540582_vuvy_l_p53u_h_g14_5c1.sat (36 members)

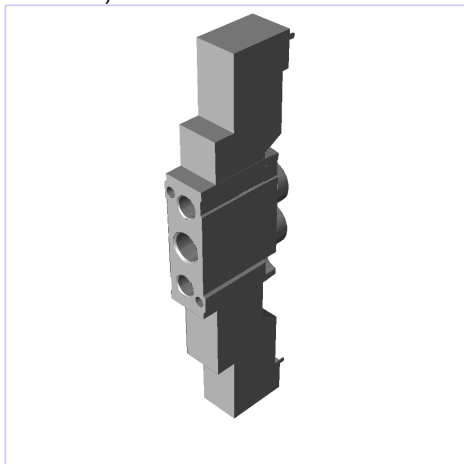

Similar parts

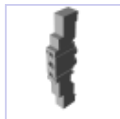

540567_vuvy_l_p53c_h_g14_1c1.sat

100.00 %

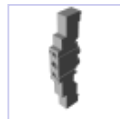

540568_vuvy_l_p53c_h_g14_2a1.sat

100.00 %

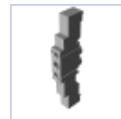

540569_vuvy_l_p53c_h_g14_3a1.sat

100.00 %

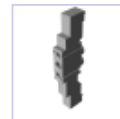

540570_vuvy_l_p53c_h_g14_5c1.sat

100.00 %

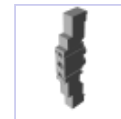

540571_vuvy_l_p53c_h_g14_8a1.sat

100.00 %



540572_vuvy_l_p53c_h_g14_9a1.sat

100.00 %

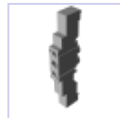

540573_vuvy_l_p53e_h_g14_1c1.sat

100.00 %

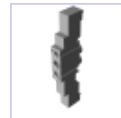

540574_vuvy_l_p53e_h_g14_2a1.sat

100.00 %

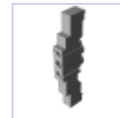

540575_vuvy_l_p53e_h_g14_3a1.sat

100.00 %

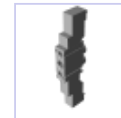

540576_vuvy_l_p53e_h_g14_5c1.sat

100.00 %

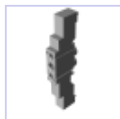

540577_vuvy_l_p53e_h_g14_8a1.sat

100.00 %

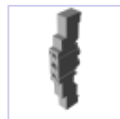

540578_vuvy_l_p53e_h_g14_9a1.sat

100.00 %

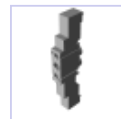

540579_vuvy_l_p53u_h_g14_1c1.sat

100.00 %

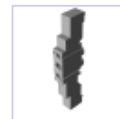

540580_vuvy_l_p53u_h_g14_2a1.sat

100.00 %

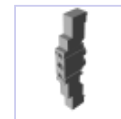

540581_vuvy_l_p53u_h_g14_3a1.sat

100.00 %

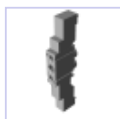

540583_vuvy_l_p53u_h_g14_8a1.sat

100.00 %

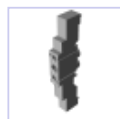

540584_vuvy_l_p53u_h_g14_9a1.sat

100.00 %

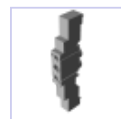

540567_vuvy_l_p53c_h_g14_1c1.stp

99.88 %

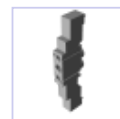

540568_vuvy_l_p53c_h_g14_2a1.stp

99.88 %

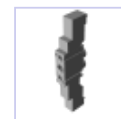

540569_vuvy_l_p53c_h_g14_3a1.stp

99.88 %

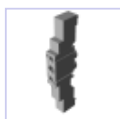

540570_vuvy_l_p53c_h_g14_5c1.stp

99.88 %

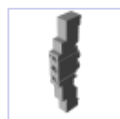

540571_vuvy_l_p53c_h_g14_8a1.stp

99.88 %

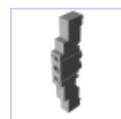

540572_vuvy_l_p53c_h_g14_9a1.stp

99.88 %

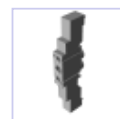

540573_vuvy_l_p53e_h_g14_1c1.stp

99.88 %

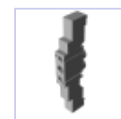

540574_vuvy_l_p53e_h_g14_2a1.stp

99.88 %

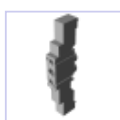

540575_vuvy_l_p53e_h_g14_3a1.stp

99.88 %

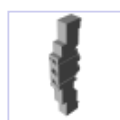

540576_vuvy_l_p53e_h_g14_5c1.stp

99.88 %

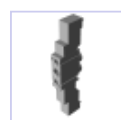

540577_vuvy_l_p53e_h_g14_8a1.stp

99.88 %

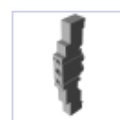

540578_vuvy_l_p53e_h_g14_9a1.stp

99.88 %

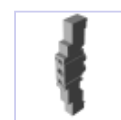

540579_vuvy_l_p53u_h_g14_1c1.stp

99.88 %

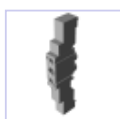

540580_vuvy_l_p53u_h_g14_2a1.stp

99.88 %

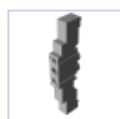

540581_vuvy_l_p53u_h_g14_3a1.stp

99.88 %

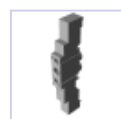

540582_vuvy_l_p53u_h_g14_5c1.stp

99.88 %

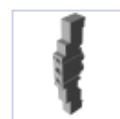

540583_vuvy_l_p53u_h_g14_8a1.stp

99.88 %

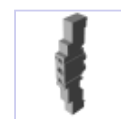

540584_vuvy_l_p53u_h_g14_9a1.stp

99.88 %

Name

476. 540581_vuvy_l_p53u_h_g14_3ac1.stp (36 members)

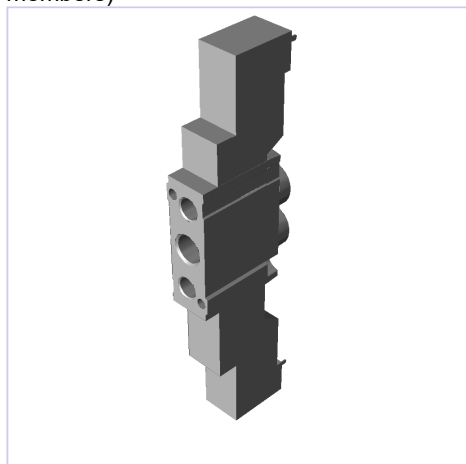

Similar parts

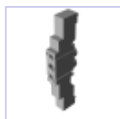

540567_vuvy_l_p53c_h_g14_1c1.stp
100.00 %

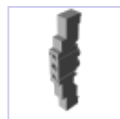

540568_vuvy_l_p53c_h_g14_2ac1.stp
100.00 %

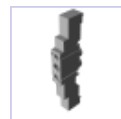

540569_vuvy_l_p53c_h_g14_3ac1.stp
100.00 %

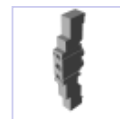

540570_vuvy_l_p53c_h_g14_5c1.stp
100.00 %

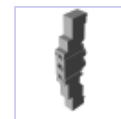

540571_vuvy_l_p53c_h_g14_8ac1.stp
100.00 %

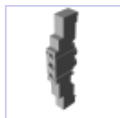

540572_vuvy_l_p53c_h_g14_9ac1.stp
100.00 %

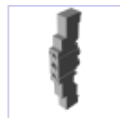

540573_vuvy_l_p53e_h_g14_1c1.stp
100.00 %

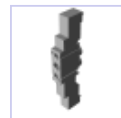

540574_vuvy_l_p53e_h_g14_2ac1.stp
100.00 %

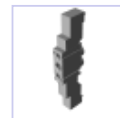

540575_vuvy_l_p53e_h_g14_3ac1.stp
100.00 %

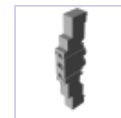

540576_vuvy_l_p53e_h_g14_5c1.stp
100.00 %

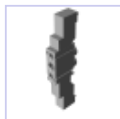

540577_vuvy_l_p53e_h_g14_8ac1.stp
100.00 %

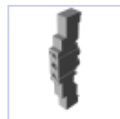

540578_vuvy_l_p53e_h_g14_9ac1.stp
100.00 %

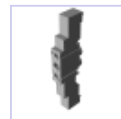

540579_vuvy_l_p53u_h_g14_1c1.stp
100.00 %

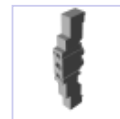

540580_vuvy_l_p53u_h_g14_2ac1.stp
100.00 %

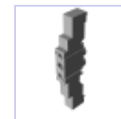

540582_vuvy_l_p53u_h_g14_5c1.stp
100.00 %

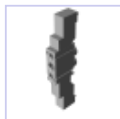

540583_vuvy_l_p53u_h_g14_8ac1.stp
100.00 %

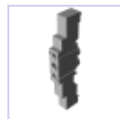

540584_vuvy_l_p53u_h_g14_9ac1.stp
100.00 %

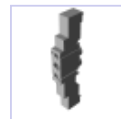

540567_vuvy_l_p53c_h_g14_1c1.sat
99.88 %

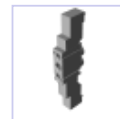

540568_vuvy_l_p53c_h_g14_2ac1.sat
99.88 %

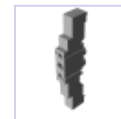

540569_vuvy_l_p53c_h_g14_3ac1.sat
99.88 %

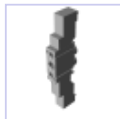

540570_vuvy_l_p53c_h_g14_5c1.sat
99.88 %

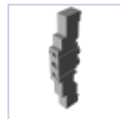

540571_vuvy_l_p53c_h_g14_8ac1.sat
99.88 %

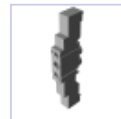

540572_vuvy_l_p53c_h_g14_9ac1.sat
99.88 %

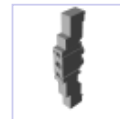

540573_vuvy_l_p53e_h_g14_1c1.sat
99.88 %

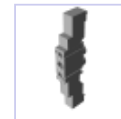

540574_vuvy_l_p53e_h_g14_2ac1.sat
99.88 %

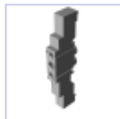

540575_vuvy_l_p53e_h_g14_3ac1.sat
99.88 %

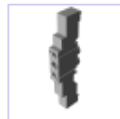

540576_vuvy_l_p53e_h_g14_5c1.sat
99.88 %

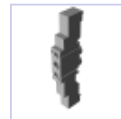

540577_vuvy_l_p53e_h_g14_8ac1.sat
99.88 %

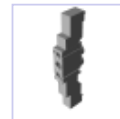

540578_vuvy_l_p53e_h_g14_9ac1.sat
99.88 %

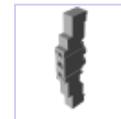

540579_vuvy_l_p53u_h_g14_1c1.sat
99.88 %

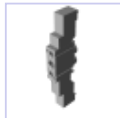

540580_vuvy_l_p53u_h_g14_2ac1.sat
99.88 %

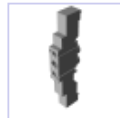

540581_vuvy_l_p53u_h_g14_3ac1.sat
99.88 %

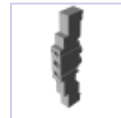

540582_vuvy_l_p53u_h_g14_5c1.sat
99.88 %

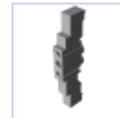

540583_vuvy_l_p53u_h_g14_8ac1.sat
99.88 %

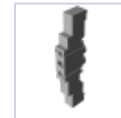

540584_vuvy_l_p53u_h_g14_9ac1.sat
99.88 %

Name

477. 540581_vuvy_l_p53u_h_g14_3ac1.sat (36 members)

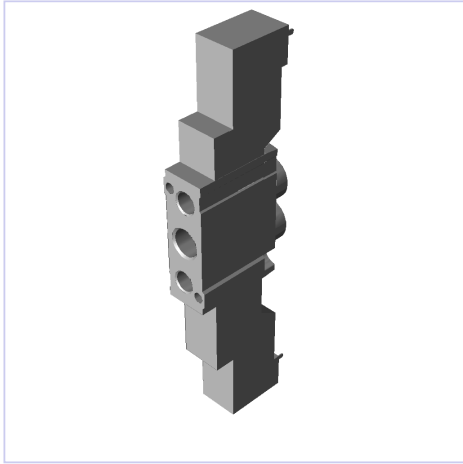

Similar parts



540567_vuvy_l_p53c_h_g14_1c1.sat
100.00 %



540568_vuvy_l_p53c_h_g14_2ac1.sat
100.00 %

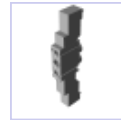

540569_vuvy_l_p53c_h_g14_3ac1.sat
100.00 %



540570_vuvy_l_p53c_h_g14_5c1.sat
100.00 %



540571_vuvy_l_p53c_h_g14_8ac1.sat
100.00 %

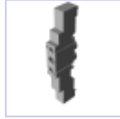

540572_vuvy_l_p53c_h_g14_9ac1.sat
100.00 %



540573_vuvy_l_p53e_h_g14_1c1.sat
100.00 %

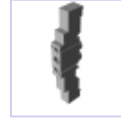

540574_vuvy_l_p53e_h_g14_2ac1.sat
100.00 %



540575_vuvy_l_p53e_h_g14_3ac1.sat
100.00 %



540576_vuvy_l_p53e_h_g14_5c1.sat
100.00 %



540577_vuvy_l_p53e_h_g14_8ac1.sat
100.00 %



540578_vuvy_l_p53e_h_g14_9ac1.sat
100.00 %

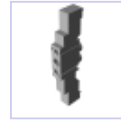

540579_vuvy_l_p53u_h_g14_1c1.sat
100.00 %

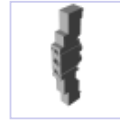

540580_vuvy_l_p53u_h_g14_2ac1.sat
100.00 %

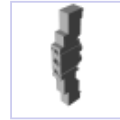

540582_vuvy_l_p53u_h_g14_5c1.sat
100.00 %



540583_vuvy_l_p53u_h_g14_8ac1.sat
100.00 %



540584_vuvy_l_p53u_h_g14_9ac1.sat
100.00 %

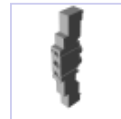

540567_vuvy_l_p53c_h_g14_1c1.stp
99.88 %

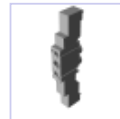

540568_vuvy_l_p53c_h_g14_2ac1.stp
99.88 %

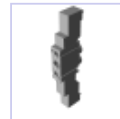

540569_vuvy_l_p53c_h_g14_3ac1.stp
99.88 %

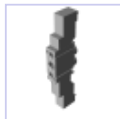

540570_vuvy_l_p53c_h_g14_5c1.stp
99.88 %

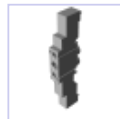

540571_vuvy_l_p53c_h_g14_8ac1.stp
99.88 %

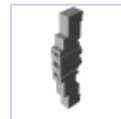

540572_vuvy_l_p53c_h_g14_9ac1.stp
99.88 %

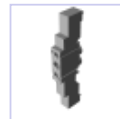

540573_vuvy_l_p53e_h_g14_1c1.stp
99.88 %

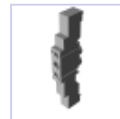

540574_vuvy_l_p53e_h_g14_2ac1.stp
99.88 %

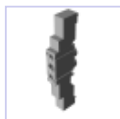

540575_vuvy_l_p53e_h_g14_3ac1.stp
99.88 %

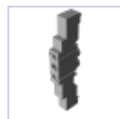

540576_vuvy_l_p53e_h_g14_5c1.stp
99.88 %

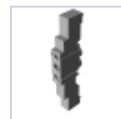

540577_vuvy_l_p53e_h_g14_8ac1.stp
99.88 %

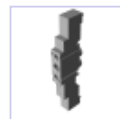

540578_vuvy_l_p53e_h_g14_9ac1.stp
99.88 %

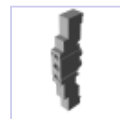

540579_vuvy_l_p53u_h_g14_1c1.stp
99.88 %

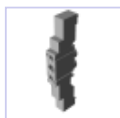

540580_vuvy_l_p53u_h_g14_2ac1.stp
99.88 %

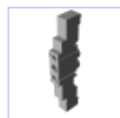

540581_vuvy_l_p53u_h_g14_3ac1.stp
99.88 %

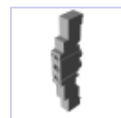

540582_vuvy_l_p53u_h_g14_5c1.stp
99.88 %

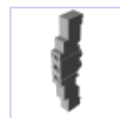

540583_vuvy_l_p53u_h_g14_8ac1.stp
99.88 %

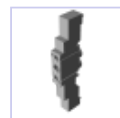

540584_vuvy_l_p53u_h_g14_9ac1.stp
99.88 %

Name

478. 540580_vuvy_l_p53u_h_g14_2ac1.stp (36 members)

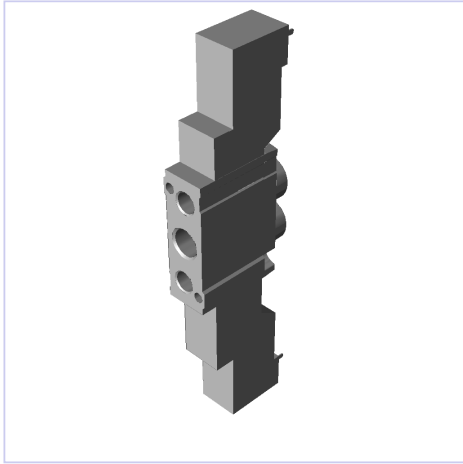

Similar parts



540567_vuvy_l_p53c_h_g14_1c1.stp
100.00 %



540568_vuvy_l_p53c_h_g14_2ac1.stp
100.00 %

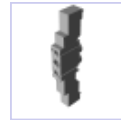

540569_vuvy_l_p53c_h_g14_3ac1.stp
100.00 %



540570_vuvy_l_p53c_h_g14_5c1.stp
100.00 %

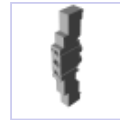

540571_vuvy_l_p53c_h_g14_8ac1.stp
100.00 %

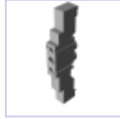

540572_vuvy_l_p53c_h_g14_9ac1.stp
100.00 %



540573_vuvy_l_p53e_h_g14_1c1.stp
100.00 %

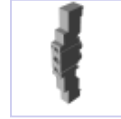

540574_vuvy_l_p53e_h_g14_2ac1.stp
100.00 %



540575_vuvy_l_p53e_h_g14_3ac1.stp
100.00 %



540576_vuvy_l_p53e_h_g14_5c1.stp
100.00 %



540577_vuvy_l_p53e_h_g14_8ac1.stp
100.00 %

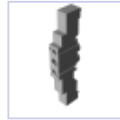

540578_vuvy_l_p53e_h_g14_9ac1.stp
100.00 %

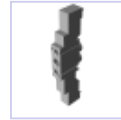

540579_vuvy_l_p53u_h_g14_1c1.stp
100.00 %



540581_vuvy_l_p53u_h_g14_3ac1.stp
100.00 %



540582_vuvy_l_p53u_h_g14_5c1.stp
100.00 %



540583_vuvy_l_p53u_h_g14_8ac1.stp
100.00 %

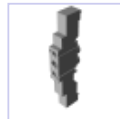

540584_vuvy_l_p53u_h_g14_9ac1.stp
100.00 %

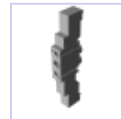

540567_vuvy_l_p53c_h_g14_1c1.sat
99.88 %

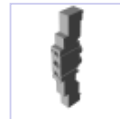

540568_vuvy_l_p53c_h_g14_2ac1.sat
99.88 %

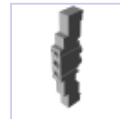

540569_vuvy_l_p53c_h_g14_3ac1.sat
99.88 %

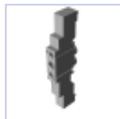

540570_vuvy_l_p53c_h_g14_5c1.sat
99.88 %

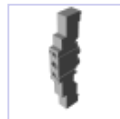

540571_vuvy_l_p53c_h_g14_8ac1.sat
99.88 %

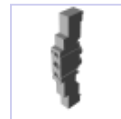

540572_vuvy_l_p53c_h_g14_9ac1.sat
99.88 %

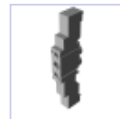

540573_vuvy_l_p53e_h_g14_1c1.sat
99.88 %

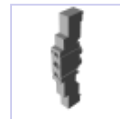

540574_vuvy_l_p53e_h_g14_2ac1.sat
99.88 %

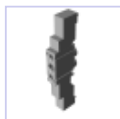

540575_vuvy_l_p53e_h_g14_3ac1.sat
99.88 %

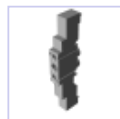

540576_vuvy_l_p53e_h_g14_5c1.sat
99.88 %

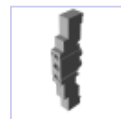

540577_vuvy_l_p53e_h_g14_8ac1.sat
99.88 %

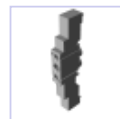

540578_vuvy_l_p53e_h_g14_9ac1.sat
99.88 %

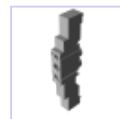

540579_vuvy_l_p53u_h_g14_1c1.sat
99.88 %

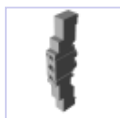

540580_vuvy_l_p53u_h_g14_2ac1.sat
99.88 %

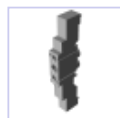

540581_vuvy_l_p53u_h_g14_3ac1.sat
99.88 %

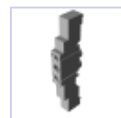

540582_vuvy_l_p53u_h_g14_5c1.sat
99.88 %

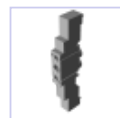

540583_vuvy_l_p53u_h_g14_8ac1.sat
99.88 %

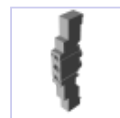

540584_vuvy_l_p53u_h_g14_9ac1.sat
99.88 %

Name

479. 540580_vuvy_l_p53u_h_g14_2ac1.sat (36 members)

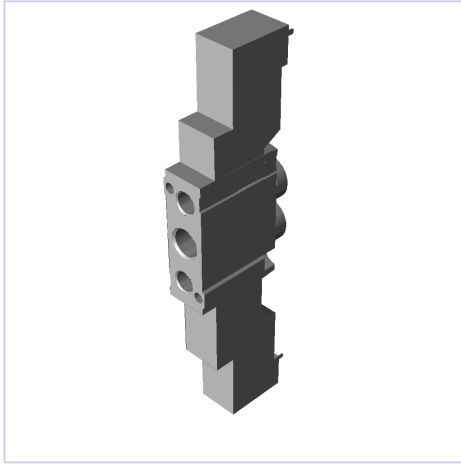

Similar parts

540567_vuvy_l_p53c_h_g14_1c1.sat 100.00 %	540568_vuvy_l_p53c_h_g14_2ac1.sat 100.00 %	540569_vuvy_l_p53c_h_g14_3ac1.sat 100.00 %	540570_vuvy_l_p53c_h_g14_5c1.sat 100.00 %	540571_vuvy_l_p53c_h_g14_8ac1.sat 100.00 %
540572_vuvy_l_p53c_h_g14_9ac1.sat 100.00 %	540573_vuvy_l_p53e_h_g14_1c1.sat 100.00 %	540574_vuvy_l_p53e_h_g14_2ac1.sat 100.00 %	540575_vuvy_l_p53e_h_g14_3ac1.sat 100.00 %	540576_vuvy_l_p53e_h_g14_5c1.sat 100.00 %
540577_vuvy_l_p53e_h_g14_8ac1.sat 100.00 %	540578_vuvy_l_p53e_h_g14_9ac1.sat 100.00 %	540579_vuvy_l_p53u_h_g14_1c1.sat 100.00 %	540581_vuvy_l_p53u_h_g14_3ac1.sat 100.00 %	540582_vuvy_l_p53u_h_g14_5c1.sat 100.00 %
540583_vuvy_l_p53u_h_g14_8ac1.sat 100.00 %	540584_vuvy_l_p53u_h_g14_9ac1.sat 100.00 %	540567_vuvy_l_p53c_h_g14_1c1.stp 99.88 %	540568_vuvy_l_p53c_h_g14_2ac1.stp 99.88 %	540569_vuvy_l_p53c_h_g14_3ac1.stp 99.88 %
540570_vuvy_l_p53c_h_g14_5c1.stp 99.88 %	540571_vuvy_l_p53c_h_g14_8ac1.stp 99.88 %	540572_vuvy_l_p53c_h_g14_9ac1.stp 99.88 %	540573_vuvy_l_p53e_h_g14_1c1.stp 99.88 %	540574_vuvy_l_p53e_h_g14_2ac1.stp 99.88 %
540575_vuvy_l_p53e_h_g14_3ac1.stp 99.88 %	540576_vuvy_l_p53e_h_g14_5c1.stp 99.88 %	540577_vuvy_l_p53e_h_g14_8ac1.stp 99.88 %	540578_vuvy_l_p53e_h_g14_9ac1.stp 99.88 %	540579_vuvy_l_p53u_h_g14_1c1.stp 99.88 %
540580_vuvy_l_p53u_h_g14_2ac1.stp 99.88 %	540581_vuvy_l_p53u_h_g14_3ac1.stp 99.88 %	540582_vuvy_l_p53u_h_g14_5c1.stp 99.88 %	540583_vuvy_l_p53u_h_g14_8ac1.stp 99.88 %	540584_vuvy_l_p53u_h_g14_9ac1.stp 99.88 %

Name

480. 540579_vuvy_l_p53u_h_g14_1c1.stp (36 members)

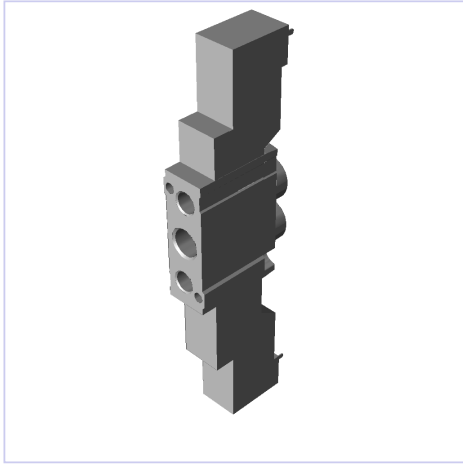

Similar parts



540567_vuvy_l_p53c_h_g14_1c1.stp
100.00 %



540568_vuvy_l_p53c_h_g14_2a1.stp
100.00 %



540569_vuvy_l_p53c_h_g14_3a1.stp
100.00 %



540570_vuvy_l_p53c_h_g14_5c1.stp
100.00 %



540571_vuvy_l_p53c_h_g14_8a1.stp
100.00 %

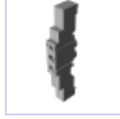

540572_vuvy_l_p53c_h_g14_9a1.stp
100.00 %



540573_vuvy_l_p53e_h_g14_1c1.stp
100.00 %



540574_vuvy_l_p53e_h_g14_2a1.stp
100.00 %



540575_vuvy_l_p53e_h_g14_3a1.stp
100.00 %



540576_vuvy_l_p53e_h_g14_5c1.stp
100.00 %

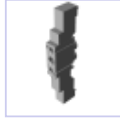

540577_vuvy_l_p53e_h_g14_8a1.stp
100.00 %



540578_vuvy_l_p53e_h_g14_9a1.stp
100.00 %



540580_vuvy_l_p53u_h_g14_2a1.stp
100.00 %



540581_vuvy_l_p53u_h_g14_3a1.stp
100.00 %



540582_vuvy_l_p53u_h_g14_5c1.stp
100.00 %



540583_vuvy_l_p53u_h_g14_8a1.stp
100.00 %



540584_vuvy_l_p53u_h_g14_9a1.stp
100.00 %

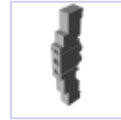

540567_vuvy_l_p53c_h_g14_1c1.sat
99.88 %



540568_vuvy_l_p53c_h_g14_2a1.sat
99.88 %



540569_vuvy_l_p53c_h_g14_3a1.sat
99.88 %



540570_vuvy_l_p53c_h_g14_5c1.sat
99.88 %



540571_vuvy_l_p53c_h_g14_8a1.sat
99.88 %

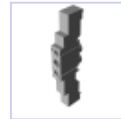

540572_vuvy_l_p53c_h_g14_9a1.sat
99.88 %

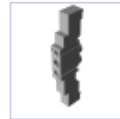

540573_vuvy_l_p53e_h_g14_1c1.sat
99.88 %

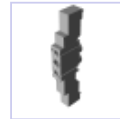

540574_vuvy_l_p53e_h_g14_2a1.sat
99.88 %



540575_vuvy_l_p53e_h_g14_3a1.sat
99.88 %



540576_vuvy_l_p53e_h_g14_5c1.sat
99.88 %

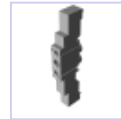

540577_vuvy_l_p53e_h_g14_8a1.sat
99.88 %

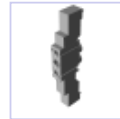

540578_vuvy_l_p53e_h_g14_9a1.sat
99.88 %

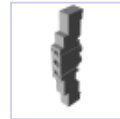

540579_vuvy_l_p53u_h_g14_1c1.sat
99.88 %



540580_vuvy_l_p53u_h_g14_2a1.sat
99.88 %



540581_vuvy_l_p53u_h_g14_3a1.sat
99.88 %



540582_vuvy_l_p53u_h_g14_5c1.sat
99.88 %



540583_vuvy_l_p53u_h_g14_8a1.sat
99.88 %



540584_vuvy_l_p53u_h_g14_9a1.sat
99.88 %

Name

481. [540579_vuvy_l_p53u_h_g14_1c1.sat](#) (36 members)

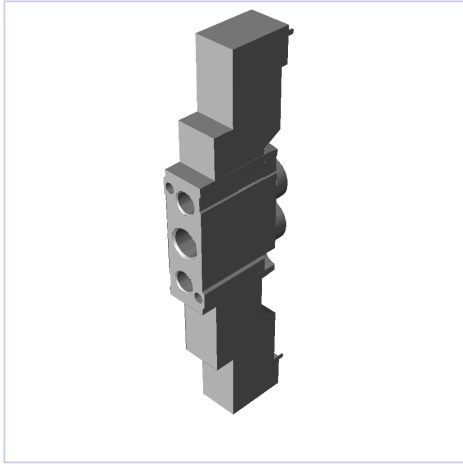

Similar parts



540567_vuvy_l_p53c_h_g14_1c1.sat
100.00 %



540568_vuvy_l_p53c_h_g14_2a1.sat
100.00 %



540569_vuvy_l_p53c_h_g14_3a1.sat
100.00 %



540570_vuvy_l_p53c_h_g14_5c1.sat
100.00 %



540571_vuvy_l_p53c_h_g14_8a1.sat
100.00 %

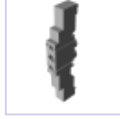

540572_vuvy_l_p53c_h_g14_9a1.sat
100.00 %



540573_vuvy_l_p53e_h_g14_1c1.sat
100.00 %



540574_vuvy_l_p53e_h_g14_2a1.sat
100.00 %



540575_vuvy_l_p53e_h_g14_3a1.sat
100.00 %



540576_vuvy_l_p53e_h_g14_5c1.sat
100.00 %



540577_vuvy_l_p53e_h_g14_8a1.sat
100.00 %



540578_vuvy_l_p53e_h_g14_9a1.sat
100.00 %

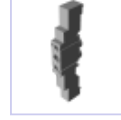

540580_vuvy_l_p53u_h_g14_2a1.sat
100.00 %

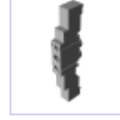

540581_vuvy_l_p53u_h_g14_3a1.sat
100.00 %

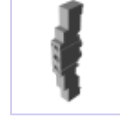

540582_vuvy_l_p53u_h_g14_5c1.sat
100.00 %

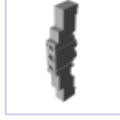

540583_vuvy_l_p53u_h_g14_8a1.sat
100.00 %



540584_vuvy_l_p53u_h_g14_9a1.sat
100.00 %



540567_vuvy_l_p53c_h_g14_1c1.stp
99.88 %

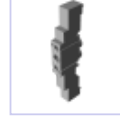

540568_vuvy_l_p53c_h_g14_2a1.stp
99.88 %

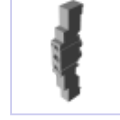

540569_vuvy_l_p53c_h_g14_3a1.stp
99.88 %



540570_vuvy_l_p53c_h_g14_5c1.stp
99.88 %



540571_vuvy_l_p53c_h_g14_8a1.stp
99.88 %

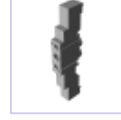

540572_vuvy_l_p53c_h_g14_9a1.stp
99.88 %



540573_vuvy_l_p53e_h_g14_1c1.stp
99.88 %



540574_vuvy_l_p53e_h_g14_2a1.stp
99.88 %



540575_vuvy_l_p53e_h_g14_3a1.stp
99.88 %

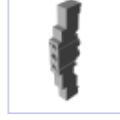

540576_vuvy_l_p53e_h_g14_5c1.stp
99.88 %



540577_vuvy_l_p53e_h_g14_8a1.stp
99.88 %



540578_vuvy_l_p53e_h_g14_9a1.stp
99.88 %



540579_vuvy_l_p53u_h_g14_1c1.stp
99.88 %



540580_vuvy_l_p53u_h_g14_2a1.stp
99.88 %



540581_vuvy_l_p53u_h_g14_3a1.stp
99.88 %



540582_vuvy_l_p53u_h_g14_5c1.stp
99.88 %



540583_vuvy_l_p53u_h_g14_8a1.stp
99.88 %



540584_vuvy_l_p53u_h_g14_9a1.stp
99.88 %

Name

482. 540578_vuvy_l_p53e_h_g14_9ac1.stp (36 members)

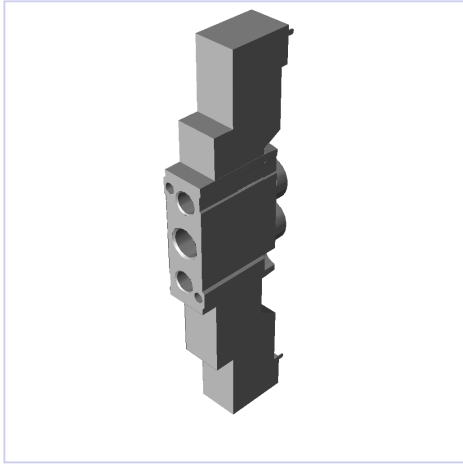

Similar parts

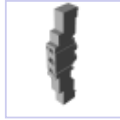

540567_vuvy_l_p53c_h_g14_1c1.stp
100.00 %



540568_vuvy_l_p53c_h_g14_2ac1.stp
100.00 %



540569_vuvy_l_p53c_h_g14_3ac1.stp
100.00 %



540570_vuvy_l_p53c_h_g14_5c1.stp
100.00 %



540571_vuvy_l_p53c_h_g14_8ac1.stp
100.00 %



540572_vuvy_l_p53c_h_g14_9ac1.stp
100.00 %



540573_vuvy_l_p53e_h_g14_1c1.stp
100.00 %



540574_vuvy_l_p53e_h_g14_2ac1.stp
100.00 %



540575_vuvy_l_p53e_h_g14_3ac1.stp
100.00 %



540576_vuvy_l_p53e_h_g14_5c1.stp
100.00 %

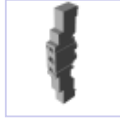

540577_vuvy_l_p53e_h_g14_8ac1.stp
100.00 %



540579_vuvy_l_p53u_h_g14_1c1.stp
100.00 %

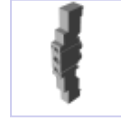

540580_vuvy_l_p53u_h_g14_2ac1.stp
100.00 %



540581_vuvy_l_p53u_h_g14_3ac1.stp
100.00 %



540582_vuvy_l_p53u_h_g14_5c1.stp
100.00 %

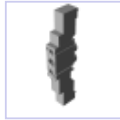

540583_vuvy_l_p53u_h_g14_8ac1.stp
100.00 %



540584_vuvy_l_p53u_h_g14_9ac1.stp
100.00 %

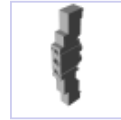

540567_vuvy_l_p53c_h_g14_1c1.sat
99.88 %

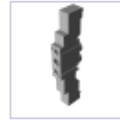

540568_vuvy_l_p53c_h_g14_2ac1.sat
99.88 %

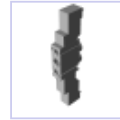

540569_vuvy_l_p53c_h_g14_3ac1.sat
99.88 %



540570_vuvy_l_p53c_h_g14_5c1.sat
99.88 %



540571_vuvy_l_p53c_h_g14_8ac1.sat
99.88 %

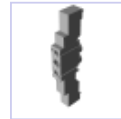

540572_vuvy_l_p53c_h_g14_9ac1.sat
99.88 %

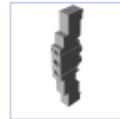

540573_vuvy_l_p53e_h_g14_1c1.sat
99.88 %

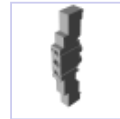

540574_vuvy_l_p53e_h_g14_2ac1.sat
99.88 %

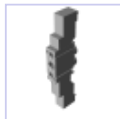

540575_vuvy_l_p53e_h_g14_3ac1.sat
99.88 %

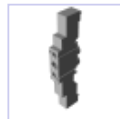

540576_vuvy_l_p53e_h_g14_5c1.sat
99.88 %

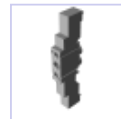

540577_vuvy_l_p53e_h_g14_8ac1.sat
99.88 %

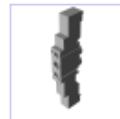

540578_vuvy_l_p53e_h_g14_9ac1.sat
99.88 %

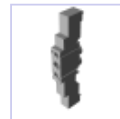

540579_vuvy_l_p53u_h_g14_1c1.sat
99.88 %

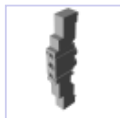

540580_vuvy_l_p53u_h_g14_2ac1.sat
99.88 %

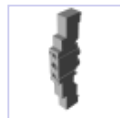

540581_vuvy_l_p53u_h_g14_3ac1.sat
99.88 %

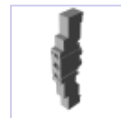

540582_vuvy_l_p53u_h_g14_5c1.sat
99.88 %

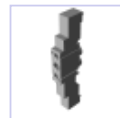

540583_vuvy_l_p53u_h_g14_8ac1.sat
99.88 %

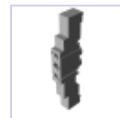

540584_vuvy_l_p53u_h_g14_9ac1.sat
99.88 %

Name

483. 540578_vuvy_l_p53e_h_g14_9ac1.sat (36 members)

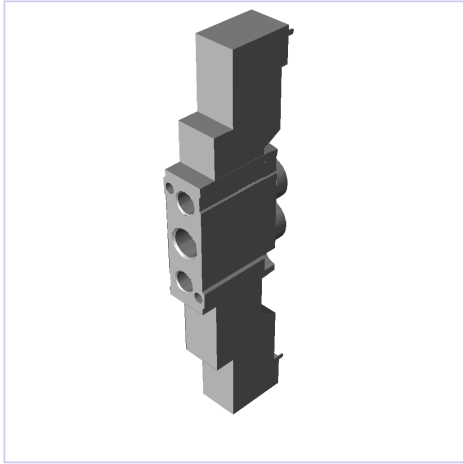

Similar parts



540567_vuvy_l_p53c_h_g14_1c1.sat
100.00 %



540568_vuvy_l_p53c_h_g14_2ac1.sat
100.00 %



540569_vuvy_l_p53c_h_g14_3ac1.sat
100.00 %



540570_vuvy_l_p53c_h_g14_5c1.sat
100.00 %



540571_vuvy_l_p53c_h_g14_8ac1.sat
100.00 %

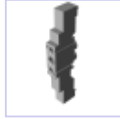

540572_vuvy_l_p53c_h_g14_9ac1.sat
100.00 %



540573_vuvy_l_p53e_h_g14_1c1.sat
100.00 %



540574_vuvy_l_p53e_h_g14_2ac1.sat
100.00 %



540575_vuvy_l_p53e_h_g14_3ac1.sat
100.00 %



540576_vuvy_l_p53e_h_g14_5c1.sat
100.00 %

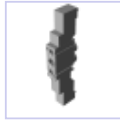

540577_vuvy_l_p53e_h_g14_8ac1.sat
100.00 %

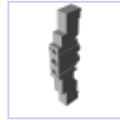

540579_vuvy_l_p53u_h_g14_1c1.sat
100.00 %

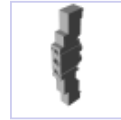

540580_vuvy_l_p53u_h_g14_2ac1.sat
100.00 %

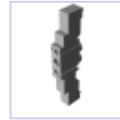

540581_vuvy_l_p53u_h_g14_3ac1.sat
100.00 %

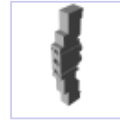

540582_vuvy_l_p53u_h_g14_5c1.sat
100.00 %

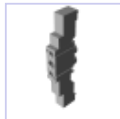

540583_vuvy_l_p53u_h_g14_8ac1.sat
100.00 %

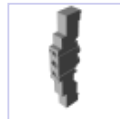

540584_vuvy_l_p53u_h_g14_9ac1.sat
100.00 %

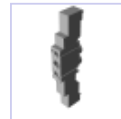

540567_vuvy_l_p53c_h_g14_1c1.stp
99.88 %

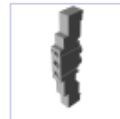

540568_vuvy_l_p53c_h_g14_2ac1.stp
99.88 %

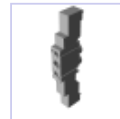

540569_vuvy_l_p53c_h_g14_3ac1.stp
99.88 %

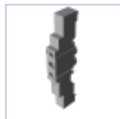

540570_vuvy_l_p53c_h_g14_5c1.stp
99.88 %

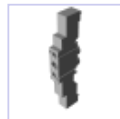

540571_vuvy_l_p53c_h_g14_8ac1.stp
99.88 %

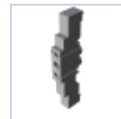

540572_vuvy_l_p53c_h_g14_9ac1.stp
99.88 %

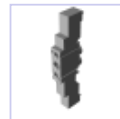

540573_vuvy_l_p53e_h_g14_1c1.stp
99.88 %

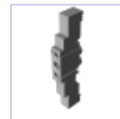

540574_vuvy_l_p53e_h_g14_2ac1.stp
99.88 %

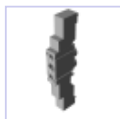

540575_vuvy_l_p53e_h_g14_3ac1.stp
99.88 %

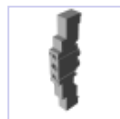

540576_vuvy_l_p53e_h_g14_5c1.stp
99.88 %

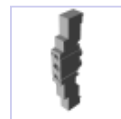

540577_vuvy_l_p53e_h_g14_8ac1.stp
99.88 %

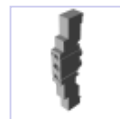

540578_vuvy_l_p53e_h_g14_9ac1.stp
99.88 %



540579_vuvy_l_p53u_h_g14_1c1.stp
99.88 %

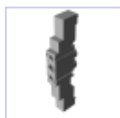

540580_vuvy_l_p53u_h_g14_2ac1.stp
99.88 %

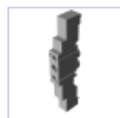

540581_vuvy_l_p53u_h_g14_3ac1.stp
99.88 %

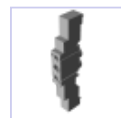

540582_vuvy_l_p53u_h_g14_5c1.stp
99.88 %



540583_vuvy_l_p53u_h_g14_8ac1.stp
99.88 %

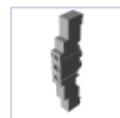

540584_vuvy_l_p53u_h_g14_9ac1.stp
99.88 %

Name

484. 540577_vuvy_l_p53e_h_g14_8ac1.stp (36 members)

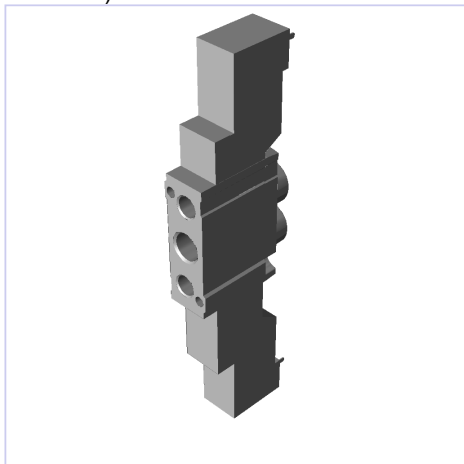

Similar parts

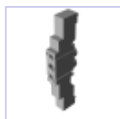

540567_vuvy_l_p53c_h_g14_1c1.stp

100.00 %

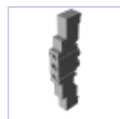

540568_vuvy_l_p53c_h_g14_2ac1.stp

100.00 %

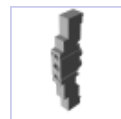

540569_vuvy_l_p53c_h_g14_3ac1.stp

100.00 %

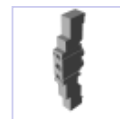

540570_vuvy_l_p53c_h_g14_5c1.stp

100.00 %

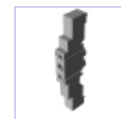

540571_vuvy_l_p53c_h_g14_8ac1.stp

100.00 %

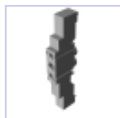

540572_vuvy_l_p53c_h_g14_9ac1.stp

100.00 %

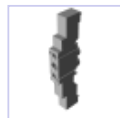

540573_vuvy_l_p53e_h_g14_1c1.stp

100.00 %



540574_vuvy_l_p53e_h_g14_2ac1.stp

100.00 %

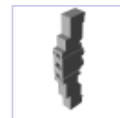

540575_vuvy_l_p53e_h_g14_3ac1.stp

100.00 %

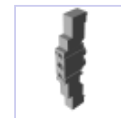

540576_vuvy_l_p53e_h_g14_5c1.stp

100.00 %

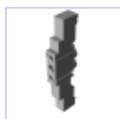

540578_vuvy_l_p53e_h_g14_9ac1.stp

100.00 %

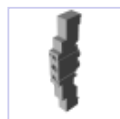

540579_vuvy_l_p53u_h_g14_1c1.stp

100.00 %

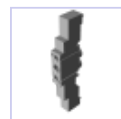

540580_vuvy_l_p53u_h_g14_2ac1.stp

100.00 %

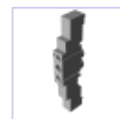

540581_vuvy_l_p53u_h_g14_3ac1.stp

100.00 %

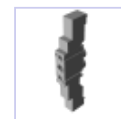

540582_vuvy_l_p53u_h_g14_5c1.stp

100.00 %

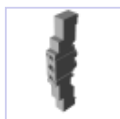

540583_vuvy_l_p53u_h_g14_8ac1.stp

100.00 %

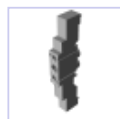

540584_vuvy_l_p53u_h_g14_9ac1.stp

100.00 %

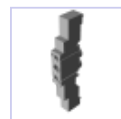

540567_vuvy_l_p53c_h_g14_1c1.sat

99.88 %

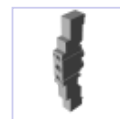

540568_vuvy_l_p53c_h_g14_2ac1.sat

99.88 %

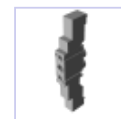

540569_vuvy_l_p53c_h_g14_3ac1.sat

99.88 %

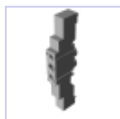

540570_vuvy_l_p53c_h_g14_5c1.sat

99.88 %

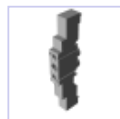

540571_vuvy_l_p53c_h_g14_8ac1.sat

99.88 %

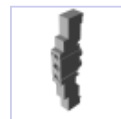

540572_vuvy_l_p53c_h_g14_9ac1.sat

99.88 %

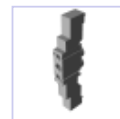

540573_vuvy_l_p53e_h_g14_1c1.sat

99.88 %

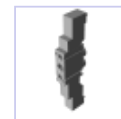

540574_vuvy_l_p53e_h_g14_2ac1.sat

99.88 %

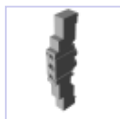

540575_vuvy_l_p53e_h_g14_3ac1.sat

99.88 %

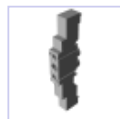

540576_vuvy_l_p53e_h_g14_5c1.sat

99.88 %

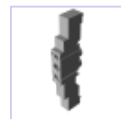

540577_vuvy_l_p53e_h_g14_8ac1.sat

99.88 %

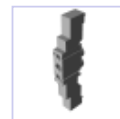

540578_vuvy_l_p53e_h_g14_9ac1.sat

99.88 %

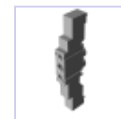

540579_vuvy_l_p53u_h_g14_1c1.sat

99.88 %

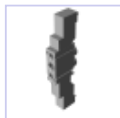

540580_vuvy_l_p53u_h_g14_2ac1.sat

99.88 %

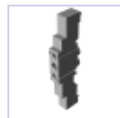

540581_vuvy_l_p53u_h_g14_3ac1.sat

99.88 %

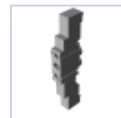

540582_vuvy_l_p53u_h_g14_5c1.sat

99.88 %

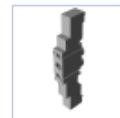

540583_vuvy_l_p53u_h_g14_8ac1.sat

99.88 %

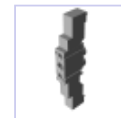

540584_vuvy_l_p53u_h_g14_9ac1.sat

99.88 %

Name

485. 540577_vuvy_l_p53e_h_g14_8ac1.sat (36 members)

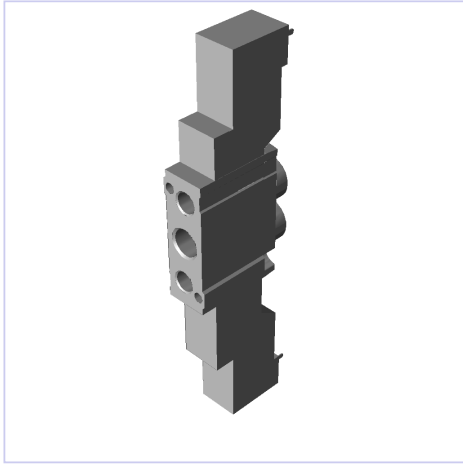

Similar parts

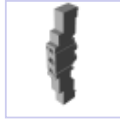

540567_vuvy_l_p53c_h_g14_1c1.sat
100.00 %



540568_vuvy_l_p53c_h_g14_2ac1.sat
100.00 %



540569_vuvy_l_p53c_h_g14_3ac1.sat
100.00 %



540570_vuvy_l_p53c_h_g14_5c1.sat
100.00 %



540571_vuvy_l_p53c_h_g14_8ac1.sat
100.00 %



540572_vuvy_l_p53c_h_g14_9ac1.sat
100.00 %



540573_vuvy_l_p53e_h_g14_1c1.sat
100.00 %



540574_vuvy_l_p53e_h_g14_2ac1.sat
100.00 %



540575_vuvy_l_p53e_h_g14_3ac1.sat
100.00 %



540576_vuvy_l_p53e_h_g14_5c1.sat
100.00 %

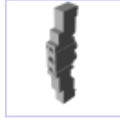

540578_vuvy_l_p53e_h_g14_9ac1.sat
100.00 %



540579_vuvy_l_p53u_h_g14_1c1.sat
100.00 %



540580_vuvy_l_p53u_h_g14_2ac1.sat
100.00 %



540581_vuvy_l_p53u_h_g14_3ac1.sat
100.00 %



540582_vuvy_l_p53u_h_g14_5c1.sat
100.00 %

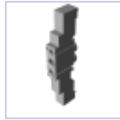

540583_vuvy_l_p53u_h_g14_8ac1.sat
100.00 %



540584_vuvy_l_p53u_h_g14_9ac1.sat
100.00 %

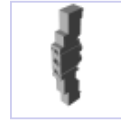

540567_vuvy_l_p53c_h_g14_1c1.stp
99.88 %

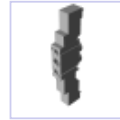

540568_vuvy_l_p53c_h_g14_2ac1.stp
99.88 %



540569_vuvy_l_p53c_h_g14_3ac1.stp
99.88 %



540570_vuvy_l_p53c_h_g14_5c1.stp
99.88 %



540571_vuvy_l_p53c_h_g14_8ac1.stp
99.88 %

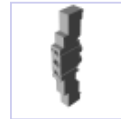

540572_vuvy_l_p53c_h_g14_9ac1.stp
99.88 %

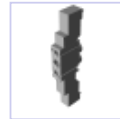

540573_vuvy_l_p53e_h_g14_1c1.stp
99.88 %

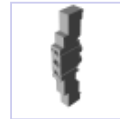

540574_vuvy_l_p53e_h_g14_2ac1.stp
99.88 %

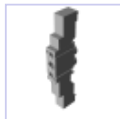

540575_vuvy_l_p53e_h_g14_3ac1.stp
99.88 %

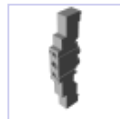

540576_vuvy_l_p53e_h_g14_5c1.stp
99.88 %

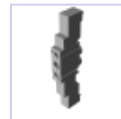

540577_vuvy_l_p53e_h_g14_8ac1.stp
99.88 %

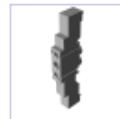

540578_vuvy_l_p53e_h_g14_9ac1.stp
99.88 %

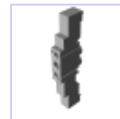

540579_vuvy_l_p53u_h_g14_1c1.stp
99.88 %

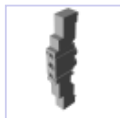

540580_vuvy_l_p53u_h_g14_2ac1.stp
99.88 %

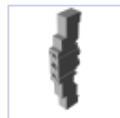

540581_vuvy_l_p53u_h_g14_3ac1.stp
99.88 %

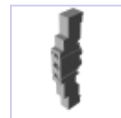

540582_vuvy_l_p53u_h_g14_5c1.stp
99.88 %

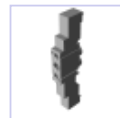

540583_vuvy_l_p53u_h_g14_8ac1.stp
99.88 %

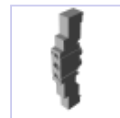

540584_vuvy_l_p53u_h_g14_9ac1.stp
99.88 %

Name

486. [540576_vuvy_l_p53e_h_g14_5c1.stp](#) (36 members)

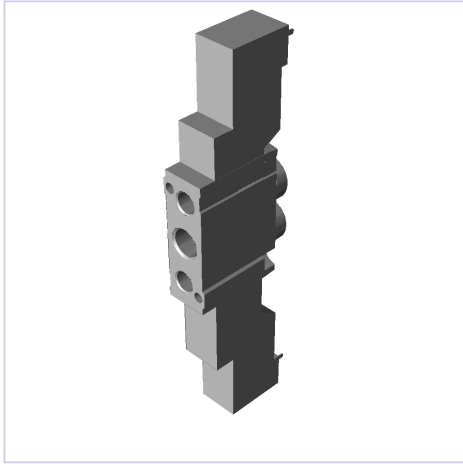

Similar parts



540567_vuvy_l_p53c_h_g14_1c1.stp
100.00 %



540568_vuvy_l_p53c_h_g14_2a1.stp
100.00 %



540569_vuvy_l_p53c_h_g14_3a1.stp
100.00 %



540570_vuvy_l_p53c_h_g14_5c1.stp
100.00 %



540571_vuvy_l_p53c_h_g14_8a1.stp
100.00 %



540572_vuvy_l_p53c_h_g14_9a1.stp
100.00 %



540573_vuvy_l_p53e_h_g14_1c1.stp
100.00 %



540574_vuvy_l_p53e_h_g14_2a1.stp
100.00 %



540575_vuvy_l_p53e_h_g14_3a1.stp
100.00 %



540577_vuvy_l_p53e_h_g14_8a1.stp
100.00 %

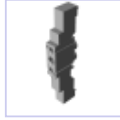

540578_vuvy_l_p53e_h_g14_9a1.stp
100.00 %



540579_vuvy_l_p53u_h_g14_1c1.stp
100.00 %



540580_vuvy_l_p53u_h_g14_2a1.stp
100.00 %



540581_vuvy_l_p53u_h_g14_3a1.stp
100.00 %

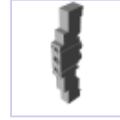

540582_vuvy_l_p53u_h_g14_5c1.stp
100.00 %

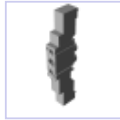

540583_vuvy_l_p53u_h_g14_8a1.stp
100.00 %



540584_vuvy_l_p53u_h_g14_9a1.stp
100.00 %

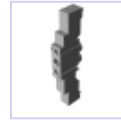

540567_vuvy_l_p53c_h_g14_1c1.sat
99.88 %

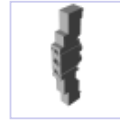

540568_vuvy_l_p53c_h_g14_2a1.sat
99.88 %



540569_vuvy_l_p53c_h_g14_3a1.sat
99.88 %



540570_vuvy_l_p53c_h_g14_5c1.sat
99.88 %



540571_vuvy_l_p53c_h_g14_8a1.sat
99.88 %

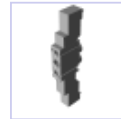

540572_vuvy_l_p53c_h_g14_9a1.sat
99.88 %



540573_vuvy_l_p53e_h_g14_1c1.sat
99.88 %

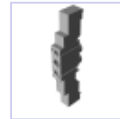

540574_vuvy_l_p53e_h_g14_2a1.sat
99.88 %

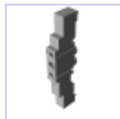

540575_vuvy_l_p53e_h_g14_3a1.sat
99.88 %

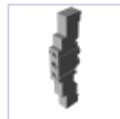

540576_vuvy_l_p53e_h_g14_5c1.sat
99.88 %

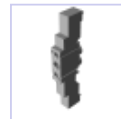

540577_vuvy_l_p53e_h_g14_8a1.sat
99.88 %

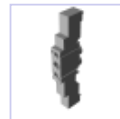

540578_vuvy_l_p53e_h_g14_9a1.sat
99.88 %

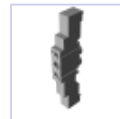

540579_vuvy_l_p53u_h_g14_1c1.sat
99.88 %

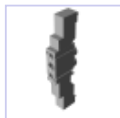

540580_vuvy_l_p53u_h_g14_2a1.sat
99.88 %

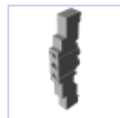

540581_vuvy_l_p53u_h_g14_3a1.sat
99.88 %

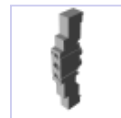

540582_vuvy_l_p53u_h_g14_5c1.sat
99.88 %

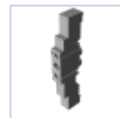

540583_vuvy_l_p53u_h_g14_8a1.sat
99.88 %

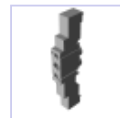

540584_vuvy_l_p53u_h_g14_9a1.sat
99.88 %

Name

487. 540576_vuvy_l_p53e_h_g14_5c1.sat (36 members)

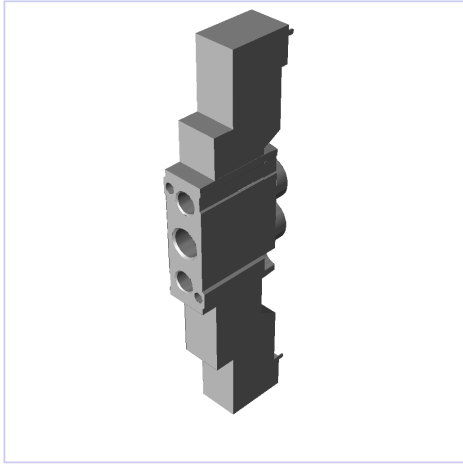

Similar parts



540567_vuvy_l_p53c_h_g14_1c1.sat
100.00 %



540568_vuvy_l_p53c_h_g14_2a1.sat
100.00 %



540569_vuvy_l_p53c_h_g14_3a1.sat
100.00 %



540570_vuvy_l_p53c_h_g14_5c1.sat
100.00 %



540571_vuvy_l_p53c_h_g14_8a1.sat
100.00 %

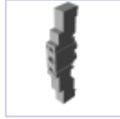

540572_vuvy_l_p53c_h_g14_9a1.sat
100.00 %



540573_vuvy_l_p53e_h_g14_1c1.sat
100.00 %

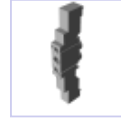

540574_vuvy_l_p53e_h_g14_2a1.sat
100.00 %



540575_vuvy_l_p53e_h_g14_3a1.sat
100.00 %



540577_vuvy_l_p53e_h_g14_8a1.sat
100.00 %

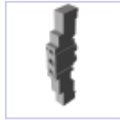

540578_vuvy_l_p53e_h_g14_9a1.sat
100.00 %



540579_vuvy_l_p53u_h_g14_1c1.sat
100.00 %

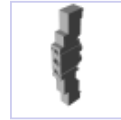

540580_vuvy_l_p53u_h_g14_2a1.sat
100.00 %



540581_vuvy_l_p53u_h_g14_3a1.sat
100.00 %



540582_vuvy_l_p53u_h_g14_5c1.sat
100.00 %

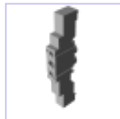

540583_vuvy_l_p53u_h_g14_8a1.sat
100.00 %

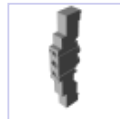

540584_vuvy_l_p53u_h_g14_9a1.sat
100.00 %

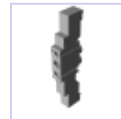

540567_vuvy_l_p53c_h_g14_1c1.stp
99.88 %

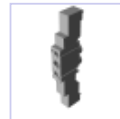

540568_vuvy_l_p53c_h_g14_2a1.stp
99.88 %

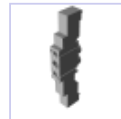

540569_vuvy_l_p53c_h_g14_3a1.stp
99.88 %

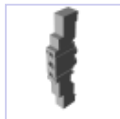

540570_vuvy_l_p53c_h_g14_5c1.stp
99.88 %

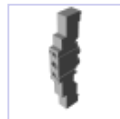

540571_vuvy_l_p53c_h_g14_8a1.stp
99.88 %

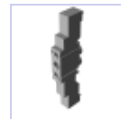

540572_vuvy_l_p53c_h_g14_9a1.stp
99.88 %

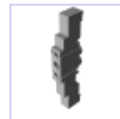

540573_vuvy_l_p53e_h_g14_1c1.stp
99.88 %

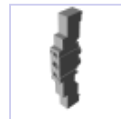

540574_vuvy_l_p53e_h_g14_2a1.stp
99.88 %

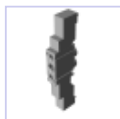

540575_vuvy_l_p53e_h_g14_3a1.stp
99.88 %

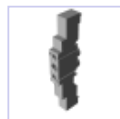

540576_vuvy_l_p53e_h_g14_5c1.stp
99.88 %

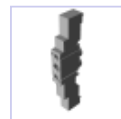

540577_vuvy_l_p53e_h_g14_8a1.stp
99.88 %



540578_vuvy_l_p53e_h_g14_9a1.stp
99.88 %

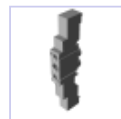

540579_vuvy_l_p53u_h_g14_1c1.stp
99.88 %

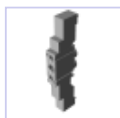

540580_vuvy_l_p53u_h_g14_2a1.stp
99.88 %

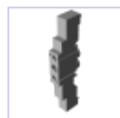

540581_vuvy_l_p53u_h_g14_3a1.stp
99.88 %

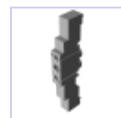

540582_vuvy_l_p53u_h_g14_5c1.stp
99.88 %

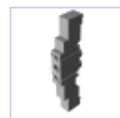

540583_vuvy_l_p53u_h_g14_8a1.stp
99.88 %

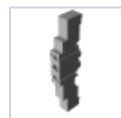

540584_vuvy_l_p53u_h_g14_9a1.stp
99.88 %

Name

488. 540575_vuvy_l_p53e_h_g14_3ac1.stp (36 members)

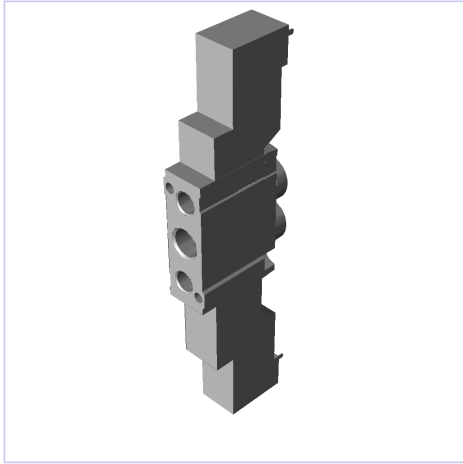

Similar parts



540567_vuvy_l_p53c_h_g14_1c1.stp
100.00 %



540568_vuvy_l_p53c_h_g14_2ac1.stp
100.00 %



540569_vuvy_l_p53c_h_g14_3ac1.stp
100.00 %



540570_vuvy_l_p53c_h_g14_5c1.stp
100.00 %



540571_vuvy_l_p53c_h_g14_8ac1.stp
100.00 %

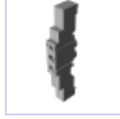

540572_vuvy_l_p53c_h_g14_9ac1.stp
100.00 %



540573_vuvy_l_p53e_h_g14_1c1.stp
100.00 %



540574_vuvy_l_p53e_h_g14_2ac1.stp
100.00 %



540576_vuvy_l_p53e_h_g14_5c1.stp
100.00 %



540577_vuvy_l_p53e_h_g14_8ac1.stp
100.00 %

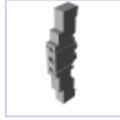

540578_vuvy_l_p53e_h_g14_9ac1.stp
100.00 %



540579_vuvy_l_p53u_h_g14_1c1.stp
100.00 %

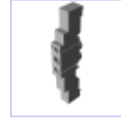

540580_vuvy_l_p53u_h_g14_2ac1.stp
100.00 %



540581_vuvy_l_p53u_h_g14_3ac1.stp
100.00 %



540582_vuvy_l_p53u_h_g14_5c1.stp
100.00 %

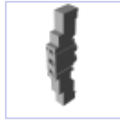

540583_vuvy_l_p53u_h_g14_8ac1.stp
100.00 %



540584_vuvy_l_p53u_h_g14_9ac1.stp
100.00 %

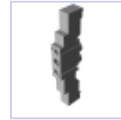

540567_vuvy_l_p53c_h_g14_1c1.sat
99.88 %

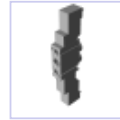

540568_vuvy_l_p53c_h_g14_2ac1.sat
99.88 %



540569_vuvy_l_p53c_h_g14_3ac1.sat
99.88 %



540570_vuvy_l_p53c_h_g14_5c1.sat
99.88 %



540571_vuvy_l_p53c_h_g14_8ac1.sat
99.88 %

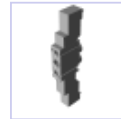

540572_vuvy_l_p53c_h_g14_9ac1.sat
99.88 %

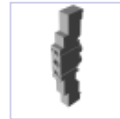

540573_vuvy_l_p53e_h_g14_1c1.sat
99.88 %

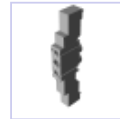

540574_vuvy_l_p53e_h_g14_2ac1.sat
99.88 %

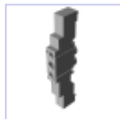

540575_vuvy_l_p53e_h_g14_3ac1.sat
99.88 %

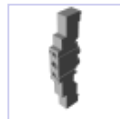

540576_vuvy_l_p53e_h_g14_5c1.sat
99.88 %

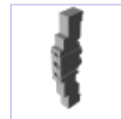

540577_vuvy_l_p53e_h_g14_8ac1.sat
99.88 %

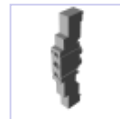

540578_vuvy_l_p53e_h_g14_9ac1.sat
99.88 %

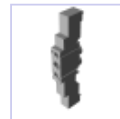

540579_vuvy_l_p53u_h_g14_1c1.sat
99.88 %

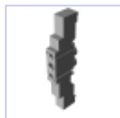

540580_vuvy_l_p53u_h_g14_2ac1.sat
99.88 %

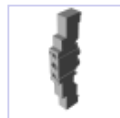

540581_vuvy_l_p53u_h_g14_3ac1.sat
99.88 %

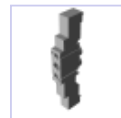

540582_vuvy_l_p53u_h_g14_5c1.sat
99.88 %

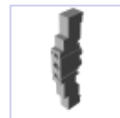

540583_vuvy_l_p53u_h_g14_8ac1.sat
99.88 %

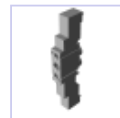

540584_vuvy_l_p53u_h_g14_9ac1.sat
99.88 %

Name

489. 540575_vuvy_l_p53e_h_g14_3ac1.sat (36 members)

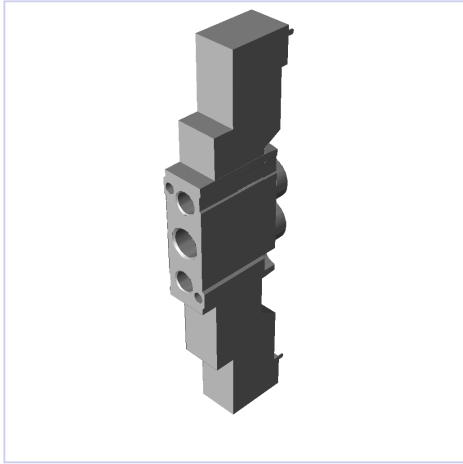

Similar parts



540567_vuvy_l_p53c_h_g14_1c1.sat
100.00 %



540568_vuvy_l_p53c_h_g14_2ac1.sat
100.00 %



540569_vuvy_l_p53c_h_g14_3ac1.sat
100.00 %



540570_vuvy_l_p53c_h_g14_5c1.sat
100.00 %



540571_vuvy_l_p53c_h_g14_8ac1.sat
100.00 %

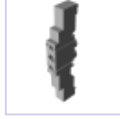

540572_vuvy_l_p53c_h_g14_9ac1.sat
100.00 %



540573_vuvy_l_p53e_h_g14_1c1.sat
100.00 %



540574_vuvy_l_p53e_h_g14_2ac1.sat
100.00 %



540576_vuvy_l_p53e_h_g14_5c1.sat
100.00 %



540577_vuvy_l_p53e_h_g14_8ac1.sat
100.00 %



540578_vuvy_l_p53e_h_g14_9ac1.sat
100.00 %



540579_vuvy_l_p53u_h_g14_1c1.sat
100.00 %

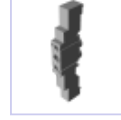

540580_vuvy_l_p53u_h_g14_2ac1.sat
100.00 %

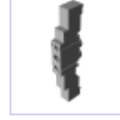

540581_vuvy_l_p53u_h_g14_3ac1.sat
100.00 %

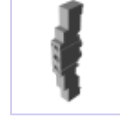

540582_vuvy_l_p53u_h_g14_5c1.sat
100.00 %

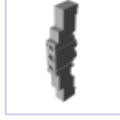

540583_vuvy_l_p53u_h_g14_8ac1.sat
100.00 %



540584_vuvy_l_p53u_h_g14_9ac1.sat
100.00 %



540567_vuvy_l_p53c_h_g14_1c1.stp
99.88 %

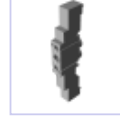

540568_vuvy_l_p53c_h_g14_2ac1.stp
99.88 %

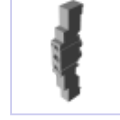

540569_vuvy_l_p53c_h_g14_3ac1.stp
99.88 %



540570_vuvy_l_p53c_h_g14_5c1.stp
99.88 %



540571_vuvy_l_p53c_h_g14_8ac1.stp
99.88 %

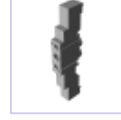

540572_vuvy_l_p53c_h_g14_9ac1.stp
99.88 %



540573_vuvy_l_p53e_h_g14_1c1.stp
99.88 %



540574_vuvy_l_p53e_h_g14_2ac1.stp
99.88 %



540575_vuvy_l_p53e_h_g14_3ac1.stp
99.88 %

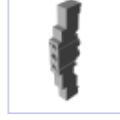

540576_vuvy_l_p53e_h_g14_5c1.stp
99.88 %



540577_vuvy_l_p53e_h_g14_8ac1.stp
99.88 %



540578_vuvy_l_p53e_h_g14_9ac1.stp
99.88 %



540579_vuvy_l_p53u_h_g14_1c1.stp
99.88 %



540580_vuvy_l_p53u_h_g14_2ac1.stp
99.88 %



540581_vuvy_l_p53u_h_g14_3ac1.stp
99.88 %



540582_vuvy_l_p53u_h_g14_5c1.stp
99.88 %



540583_vuvy_l_p53u_h_g14_8ac1.stp
99.88 %



540584_vuvy_l_p53u_h_g14_9ac1.stp
99.88 %

Name

490. 540574_vuvy_l_p53e_h_g14_2ac1.stp (36 members)

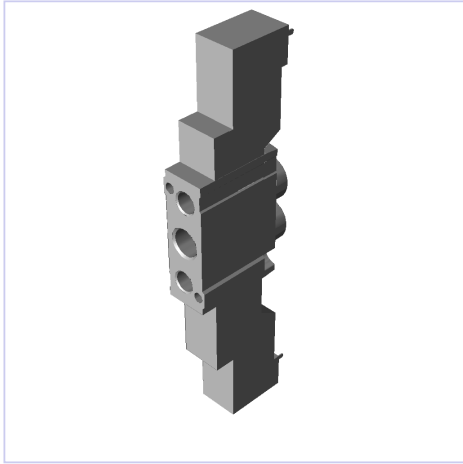

Similar parts



540567_vuvy_l_p53c_h_g14_1c1.stp
100.00 %



540568_vuvy_l_p53c_h_g14_2ac1.stp
100.00 %



540569_vuvy_l_p53c_h_g14_3ac1.stp
100.00 %



540570_vuvy_l_p53c_h_g14_5c1.stp
100.00 %

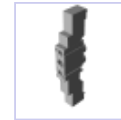

540571_vuvy_l_p53c_h_g14_8ac1.stp
100.00 %



540572_vuvy_l_p53c_h_g14_9ac1.stp
100.00 %



540573_vuvy_l_p53e_h_g14_1c1.stp
100.00 %

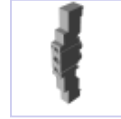

540575_vuvy_l_p53e_h_g14_3ac1.stp
100.00 %



540576_vuvy_l_p53e_h_g14_5c1.stp
100.00 %



540577_vuvy_l_p53e_h_g14_8ac1.stp
100.00 %



540578_vuvy_l_p53e_h_g14_9ac1.stp
100.00 %



540579_vuvy_l_p53u_h_g14_1c1.stp
100.00 %



540580_vuvy_l_p53u_h_g14_2ac1.stp
100.00 %



540581_vuvy_l_p53u_h_g14_3ac1.stp
100.00 %

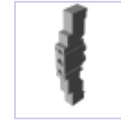

540582_vuvy_l_p53u_h_g14_5c1.stp
100.00 %

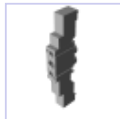

540583_vuvy_l_p53u_h_g14_8ac1.stp
100.00 %

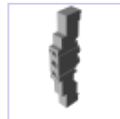

540584_vuvy_l_p53u_h_g14_9ac1.stp
100.00 %

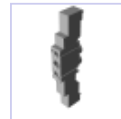

540567_vuvy_l_p53c_h_g14_1c1.sat
99.88 %

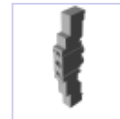

540568_vuvy_l_p53c_h_g14_2ac1.sat
99.88 %

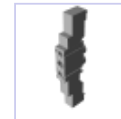

540569_vuvy_l_p53c_h_g14_3ac1.sat
99.88 %

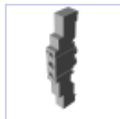

540570_vuvy_l_p53c_h_g14_5c1.sat
99.88 %

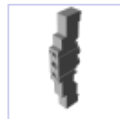

540571_vuvy_l_p53c_h_g14_8ac1.sat
99.88 %

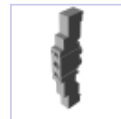

540572_vuvy_l_p53c_h_g14_9ac1.sat
99.88 %

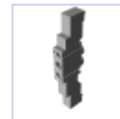

540573_vuvy_l_p53e_h_g14_1c1.sat
99.88 %

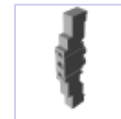

540574_vuvy_l_p53e_h_g14_2ac1.sat
99.88 %

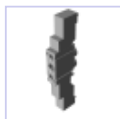

540575_vuvy_l_p53e_h_g14_3ac1.sat
99.88 %

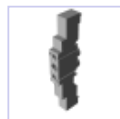

540576_vuvy_l_p53e_h_g14_5c1.sat
99.88 %

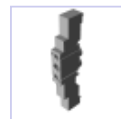

540577_vuvy_l_p53e_h_g14_8ac1.sat
99.88 %

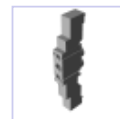

540578_vuvy_l_p53e_h_g14_9ac1.sat
99.88 %

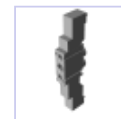

540579_vuvy_l_p53u_h_g14_1c1.sat
99.88 %

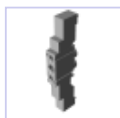

540580_vuvy_l_p53u_h_g14_2ac1.sat
99.88 %

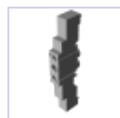

540581_vuvy_l_p53u_h_g14_3ac1.sat
99.88 %

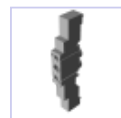

540582_vuvy_l_p53u_h_g14_5c1.sat
99.88 %

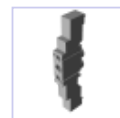

540583_vuvy_l_p53u_h_g14_8ac1.sat
99.88 %

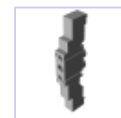

540584_vuvy_l_p53u_h_g14_9ac1.sat
99.88 %

Name

491. 540574_vuvy_l_p53e_h_g14_2ac1.sat (36 members)

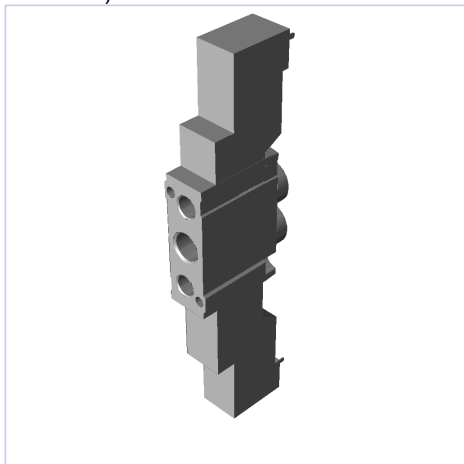

Similar parts

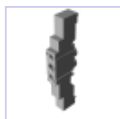

540567_vuvy_l_p53c_h_g14_1c1.sat
100.00 %

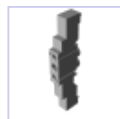

540568_vuvy_l_p53c_h_g14_2ac1.sat
100.00 %

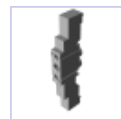

540569_vuvy_l_p53c_h_g14_3ac1.sat
100.00 %

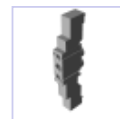

540570_vuvy_l_p53c_h_g14_5c1.sat
100.00 %

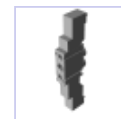

540571_vuvy_l_p53c_h_g14_8ac1.sat
100.00 %

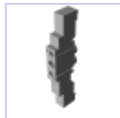

540572_vuvy_l_p53c_h_g14_9ac1.sat
100.00 %

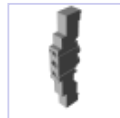

540573_vuvy_l_p53e_h_g14_1c1.sat
100.00 %

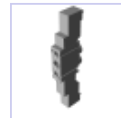

540575_vuvy_l_p53e_h_g14_3ac1.sat
100.00 %

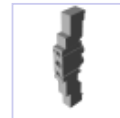

540576_vuvy_l_p53e_h_g14_5c1.sat
100.00 %

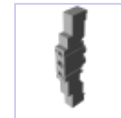

540577_vuvy_l_p53e_h_g14_8ac1.sat
100.00 %

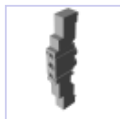

540578_vuvy_l_p53e_h_g14_9ac1.sat
100.00 %

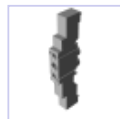

540579_vuvy_l_p53u_h_g14_1c1.sat
100.00 %

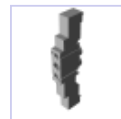

540580_vuvy_l_p53u_h_g14_2ac1.sat
100.00 %

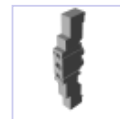

540581_vuvy_l_p53u_h_g14_3ac1.sat
100.00 %

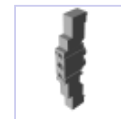

540582_vuvy_l_p53u_h_g14_5c1.sat
100.00 %

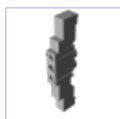

540583_vuvy_l_p53u_h_g14_8ac1.sat
100.00 %

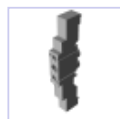

540584_vuvy_l_p53u_h_g14_9ac1.sat
100.00 %

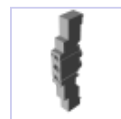

540567_vuvy_l_p53c_h_g14_1c1.stp
99.88 %

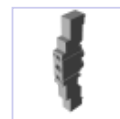

540568_vuvy_l_p53c_h_g14_2ac1.stp
99.88 %

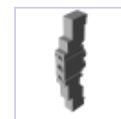

540569_vuvy_l_p53c_h_g14_3ac1.stp
99.88 %

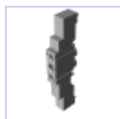

540570_vuvy_l_p53c_h_g14_5c1.stp
99.88 %

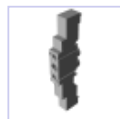

540571_vuvy_l_p53c_h_g14_8ac1.stp
99.88 %

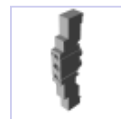

540572_vuvy_l_p53c_h_g14_9ac1.stp
99.88 %

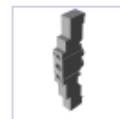

540573_vuvy_l_p53e_h_g14_1c1.stp
99.88 %

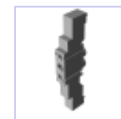

540574_vuvy_l_p53e_h_g14_2ac1.stp
99.88 %

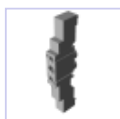

540575_vuvy_l_p53e_h_g14_3ac1.stp
99.88 %

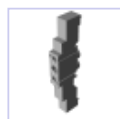

540576_vuvy_l_p53e_h_g14_5c1.stp
99.88 %

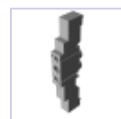

540577_vuvy_l_p53e_h_g14_8ac1.stp
99.88 %

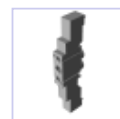

540578_vuvy_l_p53e_h_g14_9ac1.stp
99.88 %

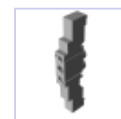

540579_vuvy_l_p53u_h_g14_1c1.stp
99.88 %

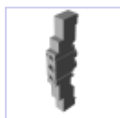

540580_vuvy_l_p53u_h_g14_2ac1.stp
99.88 %

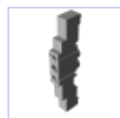

540581_vuvy_l_p53u_h_g14_3ac1.stp
99.88 %

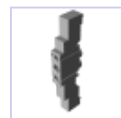

540582_vuvy_l_p53u_h_g14_5c1.stp
99.88 %

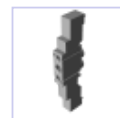

540583_vuvy_l_p53u_h_g14_8ac1.stp
99.88 %

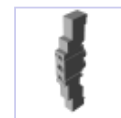

540584_vuvy_l_p53u_h_g14_9ac1.stp
99.88 %

Name

492. [540573_vuvy_l_p53e_h_g14_1c1.stp](#) (36 members)

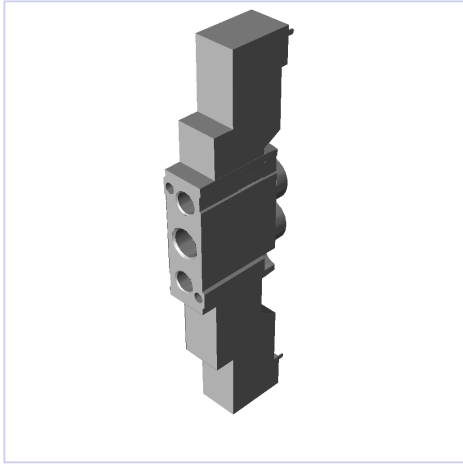

Similar parts

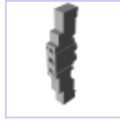

540567_vuvy_l_p53c_h_g14_1c1.stp
100.00 %



540568_vuvy_l_p53c_h_g14_2a c1.stp
100.00 %



540569_vuvy_l_p53c_h_g14_3a c1.stp
100.00 %



540570_vuvy_l_p53c_h_g14_5c1.stp
100.00 %



540571_vuvy_l_p53c_h_g14_8a c1.stp
100.00 %

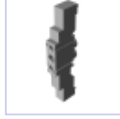

540572_vuvy_l_p53c_h_g14_9a c1.stp
100.00 %



540574_vuvy_l_p53e_h_g14_2a c1.stp
100.00 %



540575_vuvy_l_p53e_h_g14_3a c1.stp
100.00 %



540576_vuvy_l_p53e_h_g14_5c1.stp
100.00 %



540577_vuvy_l_p53e_h_g14_8a c1.stp
100.00 %



540578_vuvy_l_p53e_h_g14_9a c1.stp
100.00 %



540579_vuvy_l_p53u_h_g14_1c1.stp
100.00 %

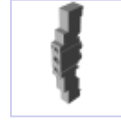

540580_vuvy_l_p53u_h_g14_2a c1.stp
100.00 %



540581_vuvy_l_p53u_h_g14_3a c1.stp
100.00 %



540582_vuvy_l_p53u_h_g14_5c1.stp
100.00 %

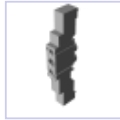

540583_vuvy_l_p53u_h_g14_8a c1.stp
100.00 %



540584_vuvy_l_p53u_h_g14_9a c1.stp
100.00 %

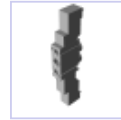

540567_vuvy_l_p53c_h_g14_1c1.sat
99.88 %

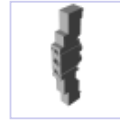

540568_vuvy_l_p53c_h_g14_2a c1.sat
99.88 %

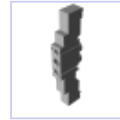

540569_vuvy_l_p53c_h_g14_3a c1.sat
99.88 %



540570_vuvy_l_p53c_h_g14_5c1.sat
99.88 %



540571_vuvy_l_p53c_h_g14_8a c1.sat
99.88 %

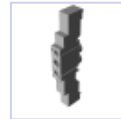

540572_vuvy_l_p53c_h_g14_9a c1.sat
99.88 %

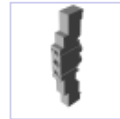

540573_vuvy_l_p53e_h_g14_1c1.sat
99.88 %

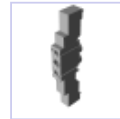

540574_vuvy_l_p53e_h_g14_2a c1.sat
99.88 %

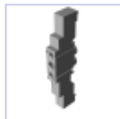

540575_vuvy_l_p53e_h_g14_3a c1.sat
99.88 %

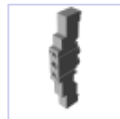

540576_vuvy_l_p53e_h_g14_5c1.sat
99.88 %

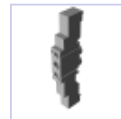

540577_vuvy_l_p53e_h_g14_8a c1.sat
99.88 %

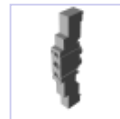

540578_vuvy_l_p53e_h_g14_9a c1.sat
99.88 %

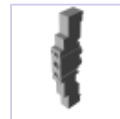

540579_vuvy_l_p53u_h_g14_1c1.sat
99.88 %

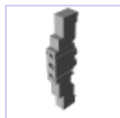

540580_vuvy_l_p53u_h_g14_2a c1.sat
99.88 %

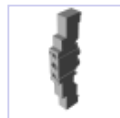

540581_vuvy_l_p53u_h_g14_3a c1.sat
99.88 %

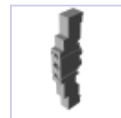

540582_vuvy_l_p53u_h_g14_5c1.sat
99.88 %



540583_vuvy_l_p53u_h_g14_8a c1.sat
99.88 %



540584_vuvy_l_p53u_h_g14_9a c1.sat
99.88 %

Name

493. 540573_vuvy_l_p53e_h_g14_1c1.sat (36 members)

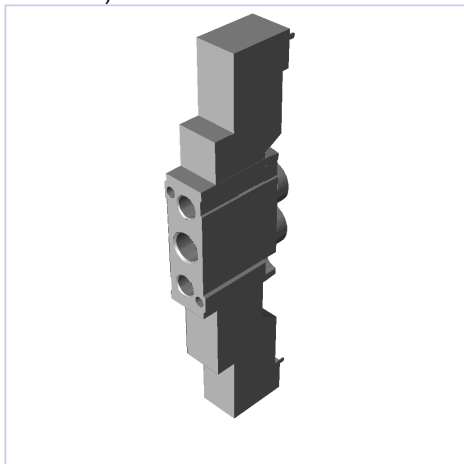

Similar parts

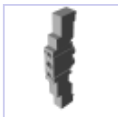

540567_vuvy_l_p53c_h_g14_1c1.sat

100.00 %

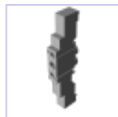

540568_vuvy_l_p53c_h_g14_2a c1.sat

100.00 %

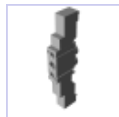

540569_vuvy_l_p53c_h_g14_3a c1.sat

100.00 %

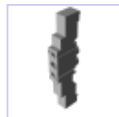

540570_vuvy_l_p53c_h_g14_5c 1.sat

100.00 %

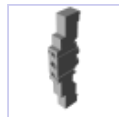

540571_vuvy_l_p53c_h_g14_8a c1.sat

100.00 %

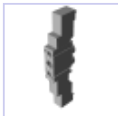

540572_vuvy_l_p53c_h_g14_9a c1.sat

100.00 %

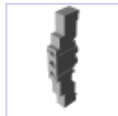

540574_vuvy_l_p53e_h_g14_2a c1.sat

100.00 %

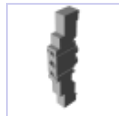

540575_vuvy_l_p53e_h_g14_3a c1.sat

100.00 %

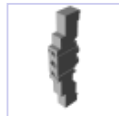

540576_vuvy_l_p53e_h_g14_5c 1.sat

100.00 %

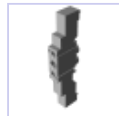

540577_vuvy_l_p53e_h_g14_8a c1.sat

100.00 %

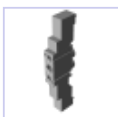

540578_vuvy_l_p53e_h_g14_9a c1.sat

100.00 %

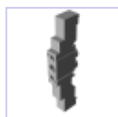

540579_vuvy_l_p53u_h_g14_1c 1.sat

100.00 %

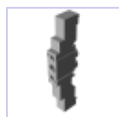

540580_vuvy_l_p53u_h_g14_2a c1.sat

100.00 %

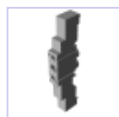

540581_vuvy_l_p53u_h_g14_3a c1.sat

100.00 %

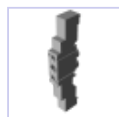

540582_vuvy_l_p53u_h_g14_5c 1.sat

100.00 %

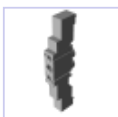

540583_vuvy_l_p53u_h_g14_8a c1.sat

100.00 %

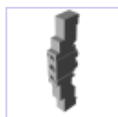

540584_vuvy_l_p53u_h_g14_9a c1.sat

100.00 %

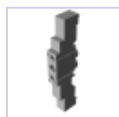

540567_vuvy_l_p53c_h_g14_1c 1.stp

99.88 %

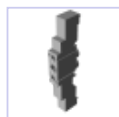

540568_vuvy_l_p53c_h_g14_2a c1.stp

99.88 %

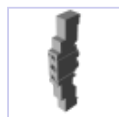

540569_vuvy_l_p53c_h_g14_3a c1.stp

99.88 %

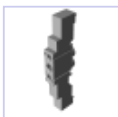

540570_vuvy_l_p53c_h_g14_5c 1.stp

99.88 %

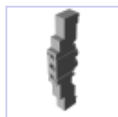

540571_vuvy_l_p53c_h_g14_8a c1.stp

99.88 %

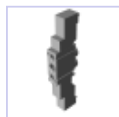

540572_vuvy_l_p53c_h_g14_9a c1.stp

99.88 %

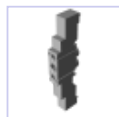

540573_vuvy_l_p53e_h_g14_1c 1.stp

99.88 %

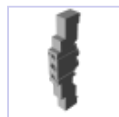

540574_vuvy_l_p53e_h_g14_2a c1.stp

99.88 %

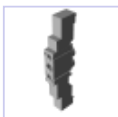

540575_vuvy_l_p53e_h_g14_3a c1.stp

99.88 %

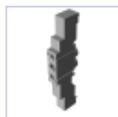

540576_vuvy_l_p53e_h_g14_5c 1.stp

99.88 %

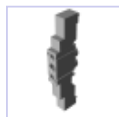

540577_vuvy_l_p53e_h_g14_8a c1.stp

99.88 %

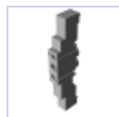

540578_vuvy_l_p53e_h_g14_9a c1.stp

99.88 %

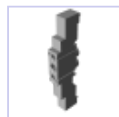

540579_vuvy_l_p53u_h_g14_1c 1.stp

99.88 %

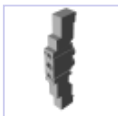

540580_vuvy_l_p53u_h_g14_2a c1.stp

99.88 %

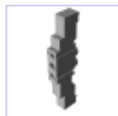

540581_vuvy_l_p53u_h_g14_3a c1.stp

99.88 %

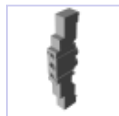

540582_vuvy_l_p53u_h_g14_5c 1.stp

99.88 %

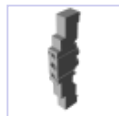

540583_vuvy_l_p53u_h_g14_8a c1.stp

99.88 %

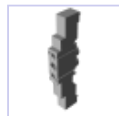

540584_vuvy_l_p53u_h_g14_9a c1.stp

99.88 %

Name

494. 540572_vuvy_l_p53c_h_g14_9ac1.stp (36 members)

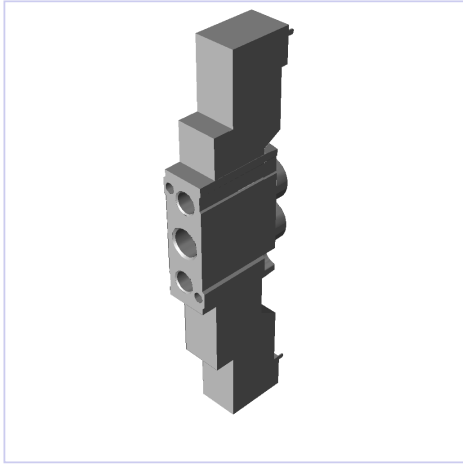

Similar parts



540567_vuvy_l_p53c_h_g14_1c1.stp
100.00 %



540568_vuvy_l_p53c_h_g14_2ac1.stp
100.00 %



540569_vuvy_l_p53c_h_g14_3ac1.stp
100.00 %



540570_vuvy_l_p53c_h_g14_5c1.stp
100.00 %



540571_vuvy_l_p53c_h_g14_8ac1.stp
100.00 %



540573_vuvy_l_p53e_h_g14_1c1.stp
100.00 %



540574_vuvy_l_p53e_h_g14_2ac1.stp
100.00 %



540575_vuvy_l_p53e_h_g14_3ac1.stp
100.00 %



540576_vuvy_l_p53e_h_g14_5c1.stp
100.00 %



540577_vuvy_l_p53e_h_g14_8ac1.stp
100.00 %

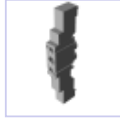

540578_vuvy_l_p53e_h_g14_9ac1.stp
100.00 %



540579_vuvy_l_p53u_h_g14_1c1.stp
100.00 %



540580_vuvy_l_p53u_h_g14_2ac1.stp
100.00 %



540581_vuvy_l_p53u_h_g14_3ac1.stp
100.00 %



540582_vuvy_l_p53u_h_g14_5c1.stp
100.00 %

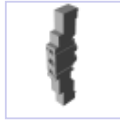

540583_vuvy_l_p53u_h_g14_8ac1.stp
100.00 %

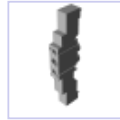

540584_vuvy_l_p53u_h_g14_9ac1.stp
100.00 %

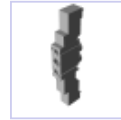

540567_vuvy_l_p53c_h_g14_1c1.sat
99.88 %

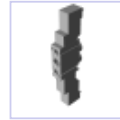

540568_vuvy_l_p53c_h_g14_2ac1.sat
99.88 %

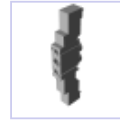

540569_vuvy_l_p53c_h_g14_3ac1.sat
99.88 %



540570_vuvy_l_p53c_h_g14_5c1.sat
99.88 %



540571_vuvy_l_p53c_h_g14_8ac1.sat
99.88 %



540572_vuvy_l_p53c_h_g14_9ac1.sat
99.88 %

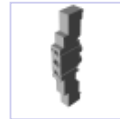

540573_vuvy_l_p53e_h_g14_1c1.sat
99.88 %

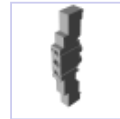

540574_vuvy_l_p53e_h_g14_2ac1.sat
99.88 %

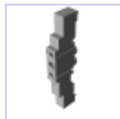

540575_vuvy_l_p53e_h_g14_3ac1.sat
99.88 %

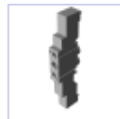

540576_vuvy_l_p53e_h_g14_5c1.sat
99.88 %

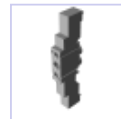

540577_vuvy_l_p53e_h_g14_8ac1.sat
99.88 %

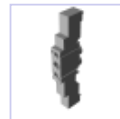

540578_vuvy_l_p53e_h_g14_9ac1.sat
99.88 %

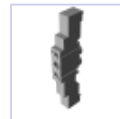

540579_vuvy_l_p53u_h_g14_1c1.sat
99.88 %

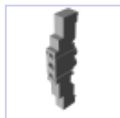

540580_vuvy_l_p53u_h_g14_2ac1.sat
99.88 %

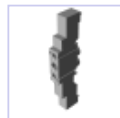

540581_vuvy_l_p53u_h_g14_3ac1.sat
99.88 %

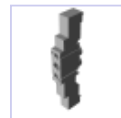

540582_vuvy_l_p53u_h_g14_5c1.sat
99.88 %

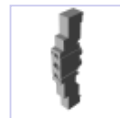

540583_vuvy_l_p53u_h_g14_8ac1.sat
99.88 %

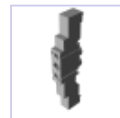

540584_vuvy_l_p53u_h_g14_9ac1.sat
99.88 %

Name

495. 540572_vuvy_l_p53c_h_g14_9ac1.sat (36 members)

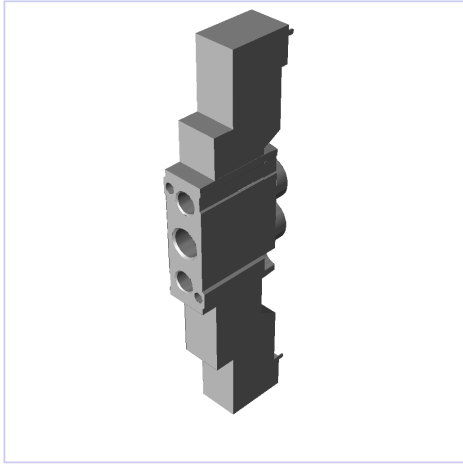

Similar parts



540567_vuvy_l_p53c_h_g14_1c1.sat
100.00 %



540568_vuvy_l_p53c_h_g14_2ac1.sat
100.00 %



540569_vuvy_l_p53c_h_g14_3ac1.sat
100.00 %



540570_vuvy_l_p53c_h_g14_5c1.sat
100.00 %



540571_vuvy_l_p53c_h_g14_8ac1.sat
100.00 %

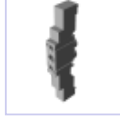

540573_vuvy_l_p53e_h_g14_1c1.sat
100.00 %



540574_vuvy_l_p53e_h_g14_2ac1.sat
100.00 %



540575_vuvy_l_p53e_h_g14_3ac1.sat
100.00 %



540576_vuvy_l_p53e_h_g14_5c1.sat
100.00 %



540577_vuvy_l_p53e_h_g14_8ac1.sat
100.00 %

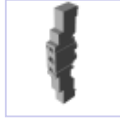

540578_vuvy_l_p53e_h_g14_9ac1.sat
100.00 %



540579_vuvy_l_p53u_h_g14_1c1.sat
100.00 %



540580_vuvy_l_p53u_h_g14_2ac1.sat
100.00 %



540581_vuvy_l_p53u_h_g14_3ac1.sat
100.00 %



540582_vuvy_l_p53u_h_g14_5c1.sat
100.00 %

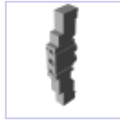

540583_vuvy_l_p53u_h_g14_8ac1.sat
100.00 %



540584_vuvy_l_p53u_h_g14_9ac1.sat
100.00 %



540567_vuvy_l_p53c_h_g14_1c1.stp
99.88 %

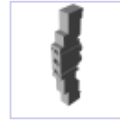

540568_vuvy_l_p53c_h_g14_2ac1.stp
99.88 %

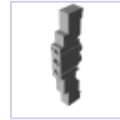

540569_vuvy_l_p53c_h_g14_3ac1.stp
99.88 %



540570_vuvy_l_p53c_h_g14_5c1.stp
99.88 %



540571_vuvy_l_p53c_h_g14_8ac1.stp
99.88 %

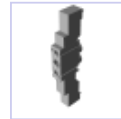

540572_vuvy_l_p53c_h_g14_9ac1.stp
99.88 %

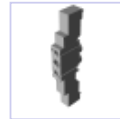

540573_vuvy_l_p53e_h_g14_1c1.stp
99.88 %

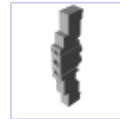

540574_vuvy_l_p53e_h_g14_2ac1.stp
99.88 %

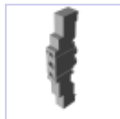

540575_vuvy_l_p53e_h_g14_3ac1.stp
99.88 %

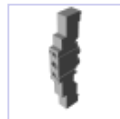

540576_vuvy_l_p53e_h_g14_5c1.stp
99.88 %

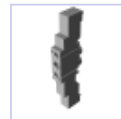

540577_vuvy_l_p53e_h_g14_8ac1.stp
99.88 %

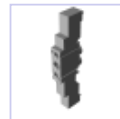

540578_vuvy_l_p53e_h_g14_9ac1.stp
99.88 %

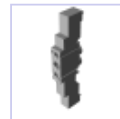

540579_vuvy_l_p53u_h_g14_1c1.stp
99.88 %

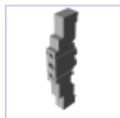

540580_vuvy_l_p53u_h_g14_2ac1.stp
99.88 %

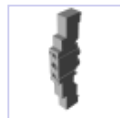

540581_vuvy_l_p53u_h_g14_3ac1.stp
99.88 %

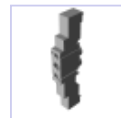

540582_vuvy_l_p53u_h_g14_5c1.stp
99.88 %

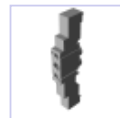

540583_vuvy_l_p53u_h_g14_8ac1.stp
99.88 %

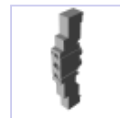

540584_vuvy_l_p53u_h_g14_9ac1.stp
99.88 %

Name

496. 540571_vuvy_l_p53c_h_g14_8ac1.stp (36 members)

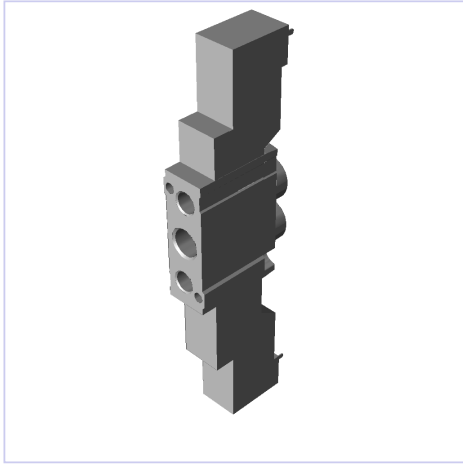

Similar parts



540567_vuvy_l_p53c_h_g14_1c1.stp
100.00 %



540568_vuvy_l_p53c_h_g14_2ac1.stp
100.00 %



540569_vuvy_l_p53c_h_g14_3ac1.stp
100.00 %



540570_vuvy_l_p53c_h_g14_5c1.stp
100.00 %



540572_vuvy_l_p53c_h_g14_9ac1.stp
100.00 %

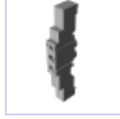

540573_vuvy_l_p53e_h_g14_1c1.stp
100.00 %



540574_vuvy_l_p53e_h_g14_2ac1.stp
100.00 %



540575_vuvy_l_p53e_h_g14_3ac1.stp
100.00 %



540576_vuvy_l_p53e_h_g14_5c1.stp
100.00 %



540577_vuvy_l_p53e_h_g14_8ac1.stp
100.00 %



540578_vuvy_l_p53e_h_g14_9ac1.stp
100.00 %



540579_vuvy_l_p53u_h_g14_1c1.stp
100.00 %



540580_vuvy_l_p53u_h_g14_2ac1.stp
100.00 %



540581_vuvy_l_p53u_h_g14_3ac1.stp
100.00 %



540582_vuvy_l_p53u_h_g14_5c1.stp
100.00 %



540583_vuvy_l_p53u_h_g14_8ac1.stp
100.00 %



540584_vuvy_l_p53u_h_g14_9ac1.stp
100.00 %

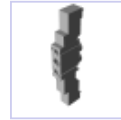

540567_vuvy_l_p53c_h_g14_1c1.sat
99.88 %



540568_vuvy_l_p53c_h_g14_2ac1.sat
99.88 %



540569_vuvy_l_p53c_h_g14_3ac1.sat
99.88 %



540570_vuvy_l_p53c_h_g14_5c1.sat
99.88 %



540571_vuvy_l_p53c_h_g14_8ac1.sat
99.88 %

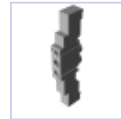

540572_vuvy_l_p53c_h_g14_9ac1.sat
99.88 %

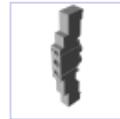

540573_vuvy_l_p53e_h_g14_1c1.sat
99.88 %

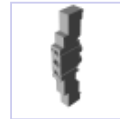

540574_vuvy_l_p53e_h_g14_2ac1.sat
99.88 %



540575_vuvy_l_p53e_h_g14_3ac1.sat
99.88 %



540576_vuvy_l_p53e_h_g14_5c1.sat
99.88 %

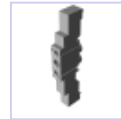

540577_vuvy_l_p53e_h_g14_8ac1.sat
99.88 %

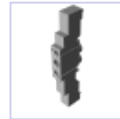

540578_vuvy_l_p53e_h_g14_9ac1.sat
99.88 %

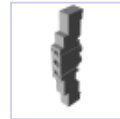

540579_vuvy_l_p53u_h_g14_1c1.sat
99.88 %



540580_vuvy_l_p53u_h_g14_2ac1.sat
99.88 %



540581_vuvy_l_p53u_h_g14_3ac1.sat
99.88 %



540582_vuvy_l_p53u_h_g14_5c1.sat
99.88 %



540583_vuvy_l_p53u_h_g14_8ac1.sat
99.88 %



540584_vuvy_l_p53u_h_g14_9ac1.sat
99.88 %

Name

497. 540571_vuvy_l_p53c_h_g14_8ac1.sat (36 members)

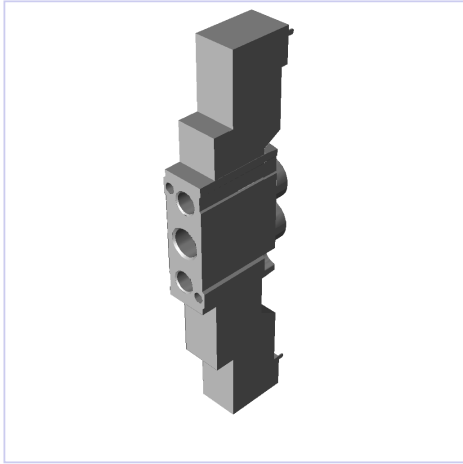

Similar parts



540567_vuvy_l_p53c_h_g14_1c1.sat
100.00 %



540568_vuvy_l_p53c_h_g14_2ac1.sat
100.00 %



540569_vuvy_l_p53c_h_g14_3ac1.sat
100.00 %



540570_vuvy_l_p53c_h_g14_5c1.sat
100.00 %



540572_vuvy_l_p53c_h_g14_9ac1.sat
100.00 %

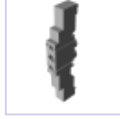

540573_vuvy_l_p53e_h_g14_1c1.sat
100.00 %



540574_vuvy_l_p53e_h_g14_2ac1.sat
100.00 %



540575_vuvy_l_p53e_h_g14_3ac1.sat
100.00 %



540576_vuvy_l_p53e_h_g14_5c1.sat
100.00 %



540577_vuvy_l_p53e_h_g14_8ac1.sat
100.00 %

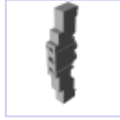

540578_vuvy_l_p53e_h_g14_9ac1.sat
100.00 %



540579_vuvy_l_p53u_h_g14_1c1.sat
100.00 %



540580_vuvy_l_p53u_h_g14_2ac1.sat
100.00 %



540581_vuvy_l_p53u_h_g14_3ac1.sat
100.00 %



540582_vuvy_l_p53u_h_g14_5c1.sat
100.00 %

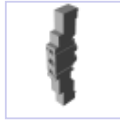

540583_vuvy_l_p53u_h_g14_8ac1.sat
100.00 %



540584_vuvy_l_p53u_h_g14_9ac1.sat
100.00 %

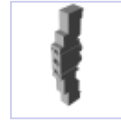

540567_vuvy_l_p53c_h_g14_1c1.stp
99.88 %

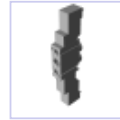

540568_vuvy_l_p53c_h_g14_2ac1.stp
99.88 %

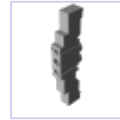

540569_vuvy_l_p53c_h_g14_3ac1.stp
99.88 %



540570_vuvy_l_p53c_h_g14_5c1.stp
99.88 %



540571_vuvy_l_p53c_h_g14_8ac1.stp
99.88 %

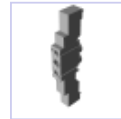

540572_vuvy_l_p53c_h_g14_9ac1.stp
99.88 %

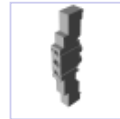

540573_vuvy_l_p53e_h_g14_1c1.stp
99.88 %



540574_vuvy_l_p53e_h_g14_2ac1.stp
99.88 %

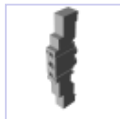

540575_vuvy_l_p53e_h_g14_3ac1.stp
99.88 %

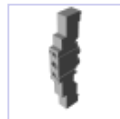

540576_vuvy_l_p53e_h_g14_5c1.stp
99.88 %

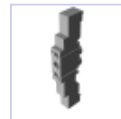

540577_vuvy_l_p53e_h_g14_8ac1.stp
99.88 %

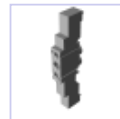

540578_vuvy_l_p53e_h_g14_9ac1.stp
99.88 %

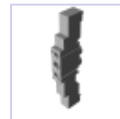

540579_vuvy_l_p53u_h_g14_1c1.stp
99.88 %

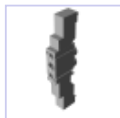

540580_vuvy_l_p53u_h_g14_2ac1.stp
99.88 %

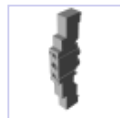

540581_vuvy_l_p53u_h_g14_3ac1.stp
99.88 %

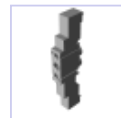

540582_vuvy_l_p53u_h_g14_5c1.stp
99.88 %

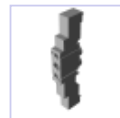

540583_vuvy_l_p53u_h_g14_8ac1.stp
99.88 %

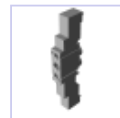

540584_vuvy_l_p53u_h_g14_9ac1.stp
99.88 %

Name

498. [540570_vuvy_l_p53c_h_g14_5c1.stp](#) (36 members)

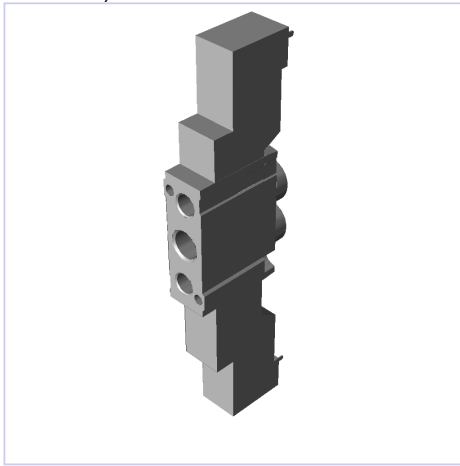

Similar parts



540567_vuvy_l_p53c_h_g14_1c1.stp
100.00 %

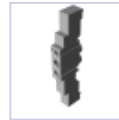

540568_vuvy_l_p53c_h_g14_2a1.stp
100.00 %



540569_vuvy_l_p53c_h_g14_3a1.stp
100.00 %

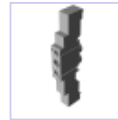

540571_vuvy_l_p53c_h_g14_8a1.stp
100.00 %

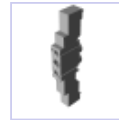

540572_vuvy_l_p53c_h_g14_9a1.stp
100.00 %



540573_vuvy_l_p53e_h_g14_1c1.stp
100.00 %



540574_vuvy_l_p53e_h_g14_2a1.stp
100.00 %



540575_vuvy_l_p53e_h_g14_3a1.stp
100.00 %



540576_vuvy_l_p53e_h_g14_5c1.stp
100.00 %



540577_vuvy_l_p53e_h_g14_8a1.stp
100.00 %

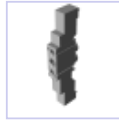

540578_vuvy_l_p53e_h_g14_9a1.stp
100.00 %



540579_vuvy_l_p53u_h_g14_1c1.stp
100.00 %

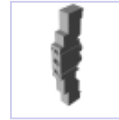

540580_vuvy_l_p53u_h_g14_2a1.stp
100.00 %



540581_vuvy_l_p53u_h_g14_3a1.stp
100.00 %

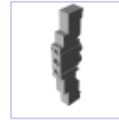

540582_vuvy_l_p53u_h_g14_5c1.stp
100.00 %

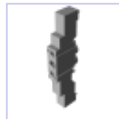

540583_vuvy_l_p53u_h_g14_8a1.stp
100.00 %

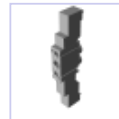

540584_vuvy_l_p53u_h_g14_9a1.stp
100.00 %

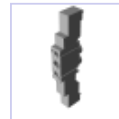

540567_vuvy_l_p53c_h_g14_1c1.sat
99.88 %

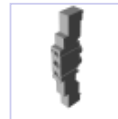

540568_vuvy_l_p53c_h_g14_2a1.sat
99.88 %

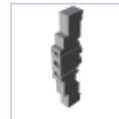

540569_vuvy_l_p53c_h_g14_3a1.sat
99.88 %

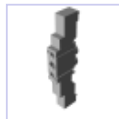

540570_vuvy_l_p53c_h_g14_5c1.sat
99.88 %

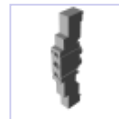

540571_vuvy_l_p53c_h_g14_8a1.sat
99.88 %

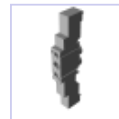

540572_vuvy_l_p53c_h_g14_9a1.sat
99.88 %

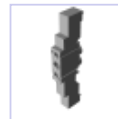

540573_vuvy_l_p53e_h_g14_1c1.sat
99.88 %

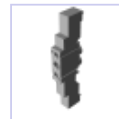

540574_vuvy_l_p53e_h_g14_2a1.sat
99.88 %

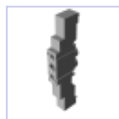

540575_vuvy_l_p53e_h_g14_3a1.sat
99.88 %

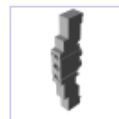

540576_vuvy_l_p53e_h_g14_5c1.sat
99.88 %

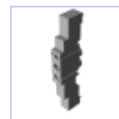

540577_vuvy_l_p53e_h_g14_8a1.sat
99.88 %

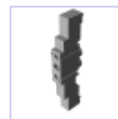

540578_vuvy_l_p53e_h_g14_9a1.sat
99.88 %

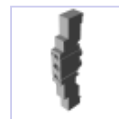

540579_vuvy_l_p53u_h_g14_1c1.sat
99.88 %

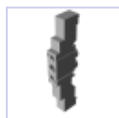

540580_vuvy_l_p53u_h_g14_2a1.sat
99.88 %

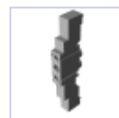

540581_vuvy_l_p53u_h_g14_3a1.sat
99.88 %



540582_vuvy_l_p53u_h_g14_5c1.sat
99.88 %

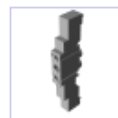

540583_vuvy_l_p53u_h_g14_8a1.sat
99.88 %

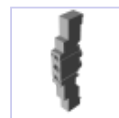

540584_vuvy_l_p53u_h_g14_9a1.sat
99.88 %

Name

499. 540570_vuvy_l_p53c_h_g14_5c1.sat (36 members)

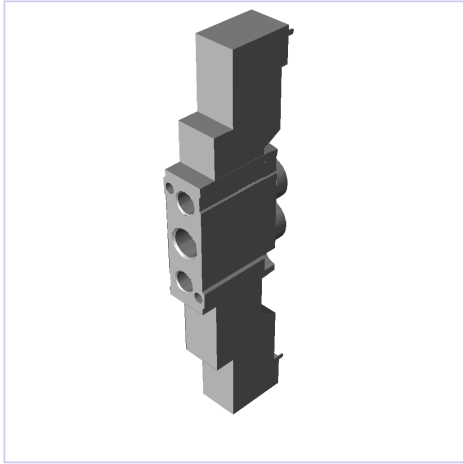

Similar parts

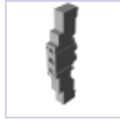

540567_vuvy_l_p53c_h_g14_1c1.sat
100.00 %



540568_vuvy_l_p53c_h_g14_2a1.sat
100.00 %



540569_vuvy_l_p53c_h_g14_3a1.sat
100.00 %



540571_vuvy_l_p53c_h_g14_8a1.sat
100.00 %



540572_vuvy_l_p53c_h_g14_9a1.sat
100.00 %

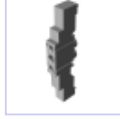

540573_vuvy_l_p53e_h_g14_1c1.sat
100.00 %



540574_vuvy_l_p53e_h_g14_2a1.sat
100.00 %



540575_vuvy_l_p53e_h_g14_3a1.sat
100.00 %



540576_vuvy_l_p53e_h_g14_5c1.sat
100.00 %



540577_vuvy_l_p53e_h_g14_8a1.sat
100.00 %



540578_vuvy_l_p53e_h_g14_9a1.sat
100.00 %



540579_vuvy_l_p53u_h_g14_1c1.sat
100.00 %



540580_vuvy_l_p53u_h_g14_2a1.sat
100.00 %



540581_vuvy_l_p53u_h_g14_3a1.sat
100.00 %



540582_vuvy_l_p53u_h_g14_5c1.sat
100.00 %

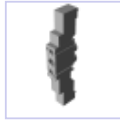

540583_vuvy_l_p53u_h_g14_8a1.sat
100.00 %



540584_vuvy_l_p53u_h_g14_9a1.sat
100.00 %

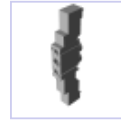

540567_vuvy_l_p53c_h_g14_1c1.stp
99.88 %



540568_vuvy_l_p53c_h_g14_2a1.stp
99.88 %



540569_vuvy_l_p53c_h_g14_3a1.stp
99.88 %



540570_vuvy_l_p53c_h_g14_5c1.stp
99.88 %



540571_vuvy_l_p53c_h_g14_8a1.stp
99.88 %

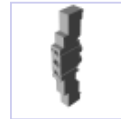

540572_vuvy_l_p53c_h_g14_9a1.stp
99.88 %

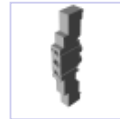

540573_vuvy_l_p53e_h_g14_1c1.stp
99.88 %

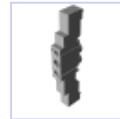

540574_vuvy_l_p53e_h_g14_2a1.stp
99.88 %

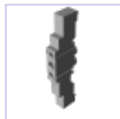

540575_vuvy_l_p53e_h_g14_3a1.stp
99.88 %

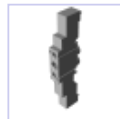

540576_vuvy_l_p53e_h_g14_5c1.stp
99.88 %

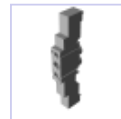

540577_vuvy_l_p53e_h_g14_8a1.stp
99.88 %

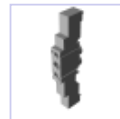

540578_vuvy_l_p53e_h_g14_9a1.stp
99.88 %

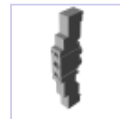

540579_vuvy_l_p53u_h_g14_1c1.stp
99.88 %

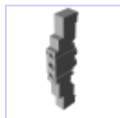

540580_vuvy_l_p53u_h_g14_2a1.stp
99.88 %

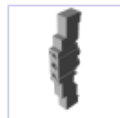

540581_vuvy_l_p53u_h_g14_3a1.stp
99.88 %

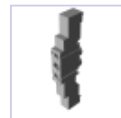

540582_vuvy_l_p53u_h_g14_5c1.stp
99.88 %

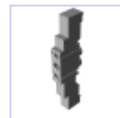

540583_vuvy_l_p53u_h_g14_8a1.stp
99.88 %

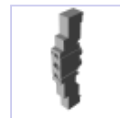

540584_vuvy_l_p53u_h_g14_9a1.stp
99.88 %

Name

500. 540569_vuvy_l_p53c_h_g14_3ac1.stp (36 members)

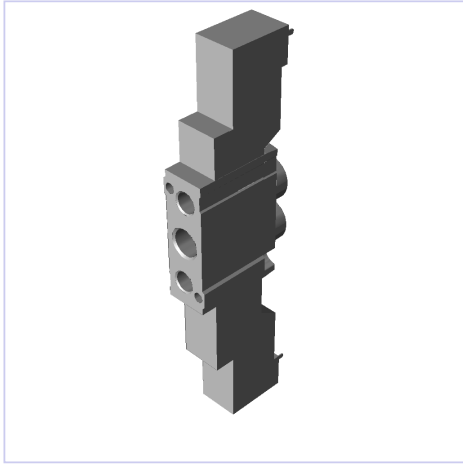

Similar parts

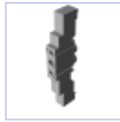

540567_vuvy_l_p53c_h_g14_1c1.stp
100.00 %

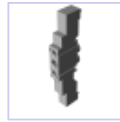

540568_vuvy_l_p53c_h_g14_2ac1.stp
100.00 %

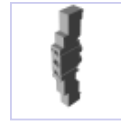

540570_vuvy_l_p53c_h_g14_5c1.stp
100.00 %

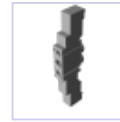

540571_vuvy_l_p53c_h_g14_8ac1.stp
100.00 %

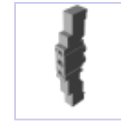

540572_vuvy_l_p53c_h_g14_9ac1.stp
100.00 %

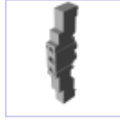

540573_vuvy_l_p53e_h_g14_1c1.stp
100.00 %



540574_vuvy_l_p53e_h_g14_2ac1.stp
100.00 %



540575_vuvy_l_p53e_h_g14_3ac1.stp
100.00 %



540576_vuvy_l_p53e_h_g14_5c1.stp
100.00 %

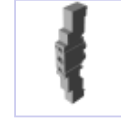

540577_vuvy_l_p53e_h_g14_8ac1.stp
100.00 %

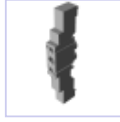

540578_vuvy_l_p53e_h_g14_9ac1.stp
100.00 %



540579_vuvy_l_p53u_h_g14_1c1.stp
100.00 %



540580_vuvy_l_p53u_h_g14_2ac1.stp
100.00 %



540581_vuvy_l_p53u_h_g14_3ac1.stp
100.00 %

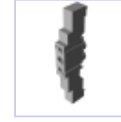

540582_vuvy_l_p53u_h_g14_5c1.stp
100.00 %



540583_vuvy_l_p53u_h_g14_8ac1.stp
100.00 %



540584_vuvy_l_p53u_h_g14_9ac1.stp
100.00 %



540567_vuvy_l_p53c_h_g14_1c1.sat
99.88 %



540568_vuvy_l_p53c_h_g14_2ac1.sat
99.88 %

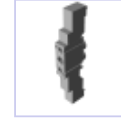

540569_vuvy_l_p53c_h_g14_3ac1.sat
99.88 %



540570_vuvy_l_p53c_h_g14_5c1.sat
99.88 %



540571_vuvy_l_p53c_h_g14_8ac1.sat
99.88 %

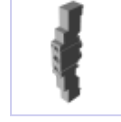

540572_vuvy_l_p53c_h_g14_9ac1.sat
99.88 %



540573_vuvy_l_p53e_h_g14_1c1.sat
99.88 %

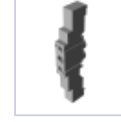

540574_vuvy_l_p53e_h_g14_2ac1.sat
99.88 %



540575_vuvy_l_p53e_h_g14_3ac1.sat
99.88 %



540576_vuvy_l_p53e_h_g14_5c1.sat
99.88 %

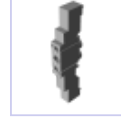

540577_vuvy_l_p53e_h_g14_8ac1.sat
99.88 %



540578_vuvy_l_p53e_h_g14_9ac1.sat
99.88 %

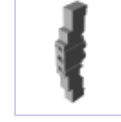

540579_vuvy_l_p53u_h_g14_1c1.sat
99.88 %



540580_vuvy_l_p53u_h_g14_2ac1.sat
99.88 %

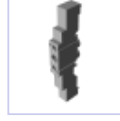

540581_vuvy_l_p53u_h_g14_3ac1.sat
99.88 %

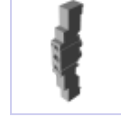

540582_vuvy_l_p53u_h_g14_5c1.sat
99.88 %

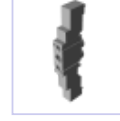

540583_vuvy_l_p53u_h_g14_8ac1.sat
99.88 %

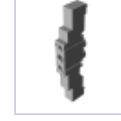









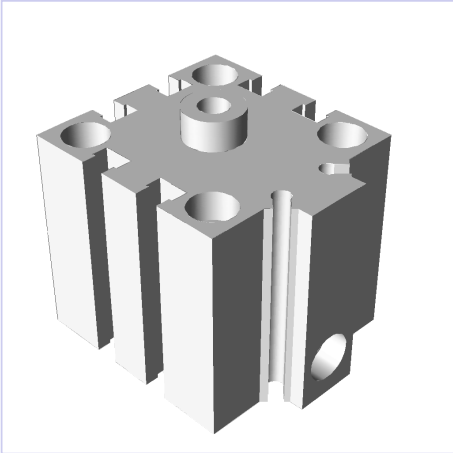

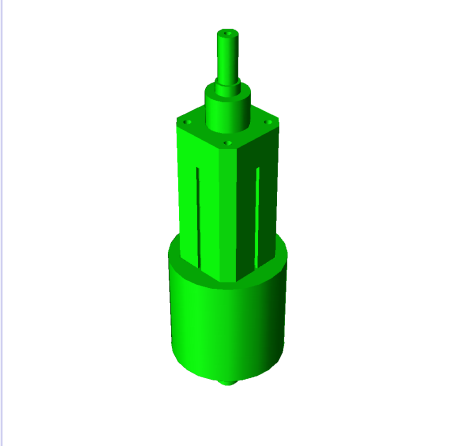

540584_vuvy_l_p53u_h_g14_9ac1.sat
99.88 %

Shape Analytics of different-named models in dataset [REDACTED] with 85.00 % cutoff (11406 groups equivalent to 30015 pairs of matches)

The left column displays each model in the dataset [REDACTED] that has one or more matching parts in the same dataset. The right column displays each of these matching parts. Each entry in the right column has a score between 0% and 100%, where 100% indicates an exact geometric match.

Results per page: Go to page:
 Page: [prev](#) | [1](#) | ... | [195](#) | [196](#) | [197](#) | [198](#) | [199](#) | [200](#) | [201](#) | [202](#) | [203](#) | [204](#) | [205](#) | ... | [229](#) | [next](#)

#	Name	Similar parts
9951.	AEVC_032_10_I_P_A.model (7 members)	<div style="display: flex; justify-content: space-around;"> <div style="text-align: center;">  </div> <div style="text-align: center;">  aevc_032_10_i_p_a.prt 99.04 % </div> <div style="text-align: center;">  aevc_032_10_i_p_a.stp 98.90 % </div> <div style="text-align: center;">  ADVC_032_10_I_P_A.model 91.69 % </div> <div style="text-align: center;">  advc_032_10_i_p_a.stp 91.24 % </div> <div style="text-align: center;">  advc_032_15_i_p.stp 87.86 % </div> </div> <div style="margin-top: 10px;"> <div style="text-align: center;">  ADVC_032_15_I_P.model 87.79 % </div> </div>
9952.	dsl-40-025-270-p-s20-ff-kf.stp (6 members)	<div style="display: flex; justify-content: space-around;"> <div style="text-align: center;">  </div> <div style="text-align: center;">  dsl_40_025_270_p_s20_ff_kf.prt 100.00 % </div> <div style="text-align: center;">  DSL_40_025_270_P_S20_FF_KF.model 98.64 % </div> <div style="text-align: center;">  DSL_40_040_270_P_S20_FF_KF.model 88.66 % </div> <div style="text-align: center;">  dsl-40-040-270-p-s20-ff-kf.stp 88.24 % </div> <div style="text-align: center;">  dsl_40_040_270_p_s20_ff_kf.prt 88.20 % </div> </div>

Name
 9953. [AEVU_032_15_A_P_A.model](#) (13 members)

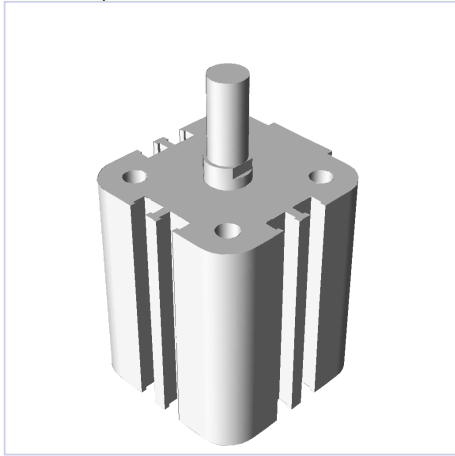

Similar parts

AEVULQ_032_15_A_P_A.model 99.41 %	aevu_032_15_a_p_a.stp 99.24 %	aevulq_032_15_a_p_a.stp 99.15 %	advu_032_015_a_p_a.prt 94.59 %	ADVU_032_15_A_P_A.model 94.56 %
ADVULQ_032_15_A_P_A.model 94.50 %	advu_032_15_a_p_a.stp 94.38 %	advulq_032_15_a_p_a.stp 94.30 %	aevu_032_15_p_a_S2.stp 85.98 %	AEVU_032_15_P_A_S2.model 85.82 %
aevulq_032_15_p_a_S2.stp 85.52 %	AEVULQ_032_15_P_A_S2.model 85.42 %			

9954. [eseu_40_025_p_a.stp](#) (4 members)

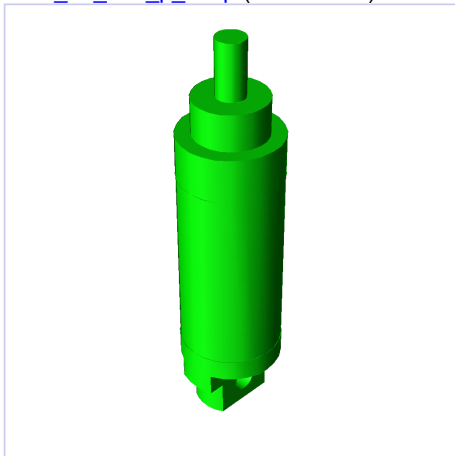

ESEU_40_025_P_A.model 99.04 %	dseu_40_040_p_a.stp 89.64 %	DSEU_40_040_P_A.model 89.54 %

9955. [DZH_16_160_PPV_A_S20.model](#) (4 members)



dzh_16_160_ppv_a_s20.stp 96.98 %	dzh_16_160_ppv_a_s2.stp 91.04 %	DZH_16_160_PPV_A_S20.model 90.20 %

Name
 9956. [aevc_040_25_i_p.stp](#) (5 members)

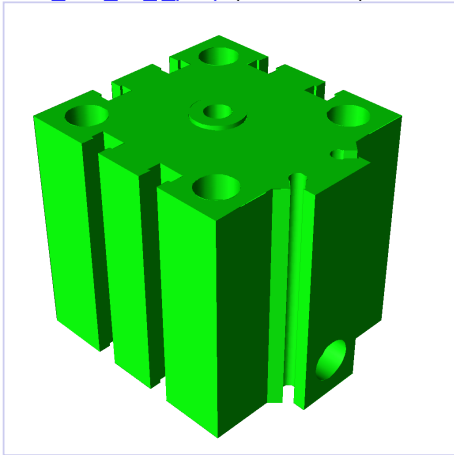

Similar parts

aevc_040_25_i_p.prt 99.30 %	AEVC_040_25_I_P.model 98.78 %	advc_040_15_i_p_a.stp 86.61 %	ADV_C_040_15_I_P_A.model 86.25 %

9957. [aevu_032_15_a_p_a.stp](#) (13 members)

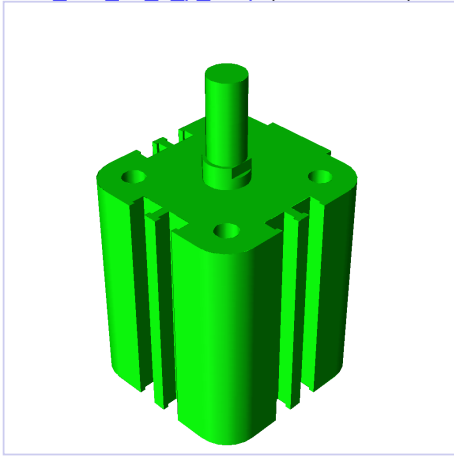

aevulq_032_15_a_p_a.stp 99.42 %	AEVU_032_15_A_P_A.model 99.24 %	AEVULQ_032_15_A_P_A.model 99.09 %	advu_032_015_a_p_a.prt 94.59 %	ADVU_032_15_A_P_A.model 94.46 %
ADVULQ_032_15_A_P_A.model 94.44 %	advu_032_15_a_p_a.stp 94.41 %	advulq_032_15_a_p_a.stp 94.34 %	aevu_032_15_p_a_S2.stp 86.01 %	AEVU_032_15_P_A_S2.model 85.84 %
aevulq_032_15_p_a_S2.stp 85.53 %	AEVULQ_032_15_P_A_S2.model 85.44 %			

9958. [ctlf_50_000_fw_pv_xc.igs](#) (6 members)

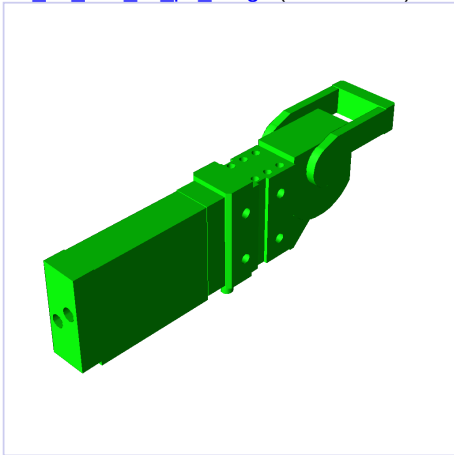

ctlf_50_000_fw_pv_xc.stp 99.65 %	ctlf_50_000_fw_pv_xc.prt 99.64 %	ctlf_50_015_fw_pv_xc.stp 88.18 %	ctlf_50_015_fw_pv_xc.prt 88.16 %	ctlf_50_015_fw_pv_xc.igs 88.04 %

[Name](#)

9959. [ctlf_50_000_fw_pv_xc.stp](#) (6 members)

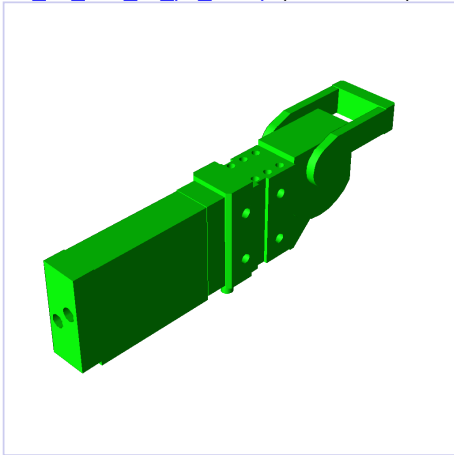

[Similar parts](#)

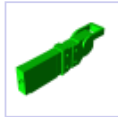

ctlf_50_000_fw_pv_xc.prt
99.88 %

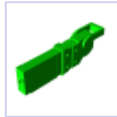

ctlf_50_000_fw_pv_xc.igs
99.65 %



ctlf_50_015_fw_pv_xc.stp
88.12 %

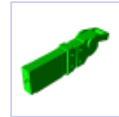

ctlf_50_015_fw_pv_xc.prt
88.09 %

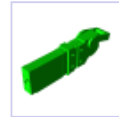

ctlf_50_015_fw_pv_xc.igs
87.93 %

9960. [AEVU_063_10_A_P_A.model](#) (12 members)

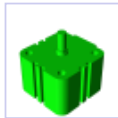
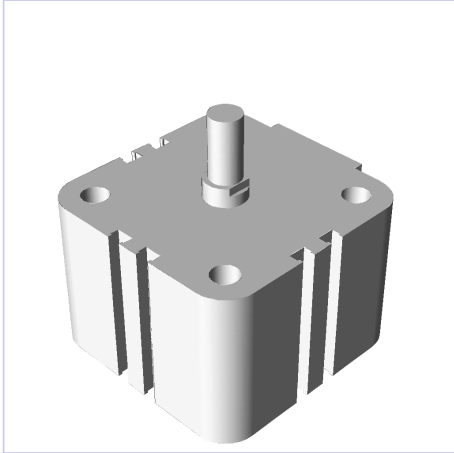

aevu_063_10_a_p_a.stp
99.29 %

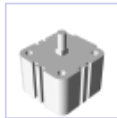

AEVULQ_063_10_A_P_A.model
99.05 %

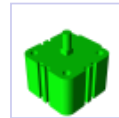

aevulq_063_10_a_p_a.stp
98.91 %

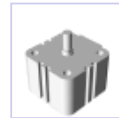

ADVU_063_10_A_P_A.model
95.67 %

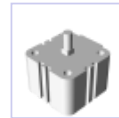

ADVULQ_063_10_A_P_A.model
95.57 %

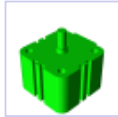

advu_063_10_a_p_a.stp
95.37 %

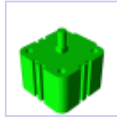

advulq_063_10_a_p_a.stp
95.31 %

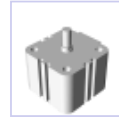

AEVU_063_15_A_P_A.model
85.33 %

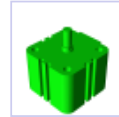

aevu_063_15_a_p_a.stp
85.23 %

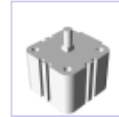

AEVULQ_063_15_A_P_A.model
85.17 %

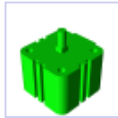

aevulq_063_15_a_p_a.stp
85.15 %

9961. [ctlf_63_060_fw_pv_xc.stp](#) (6 members)

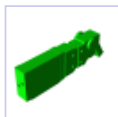
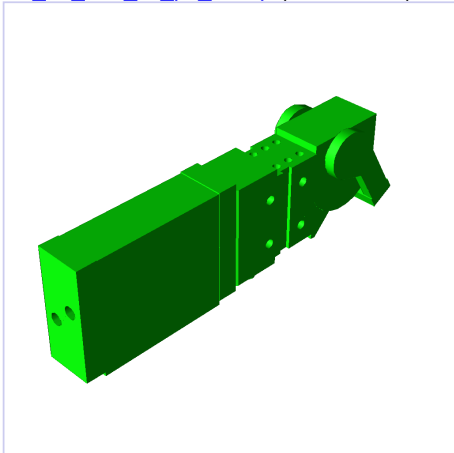

ctlf_63_060_fw_pv_xc.prt
99.85 %

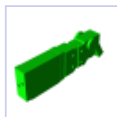

ctlf_63_060_fw_pv_xc.igs
99.68 %

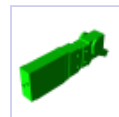

ctlf_63_120_fw_ph_xc.prt
88.09 %

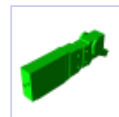

ctlf_63_120_fw_ph_xc.stp
88.04 %

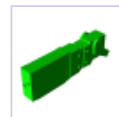

ctlf_63_120_fw_ph_xc.igs
87.98 %

Name
9962. [ctlf_50_000_fw_pv_xc.prt](#) (6 members)

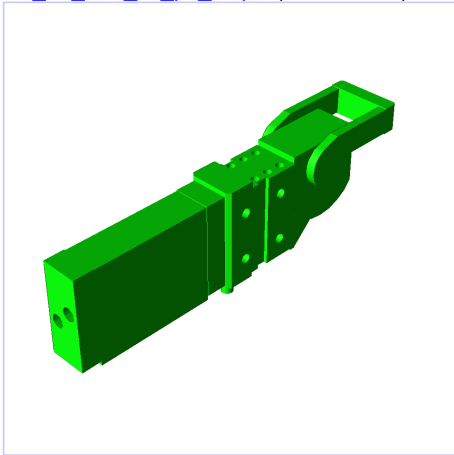

Similar parts

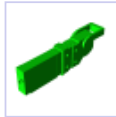

[ctlf_50_000_fw_pv_xc.stp](#)
99.88 %

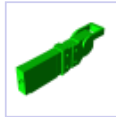

[ctlf_50_000_fw_pv_xc.igs](#)
99.64 %

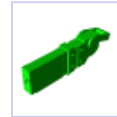

[ctlf_50_015_fw_pv_xc.stp](#)
88.11 %



[ctlf_50_015_fw_pv_xc.prt](#)
88.08 %

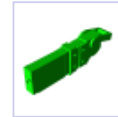

[ctlf_50_015_fw_pv_xc.igs](#)
87.93 %

9963. [aevc_004_025_a_p.stp](#) (5 members)

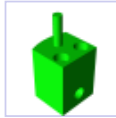
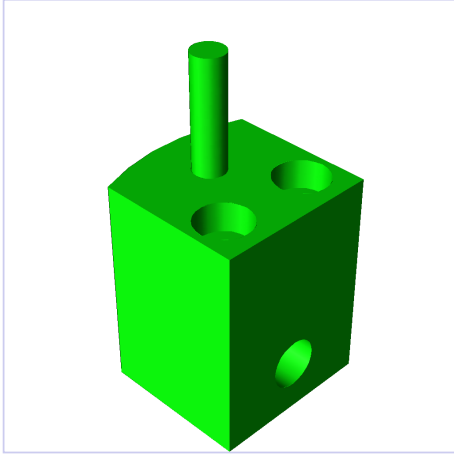

[aevc_004_025_a_p.prt](#)
99.78 %

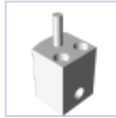

[AEVC_004_025_A_P.model](#)
98.78 %



[ADVC_004_025_A_P.model](#)
86.36 %

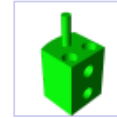

[advc_004_025_a_p.stp](#)
85.98 %

9964. [ctlf_63_120_fw_ph_xc.prt](#) (6 members)

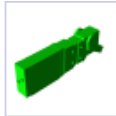
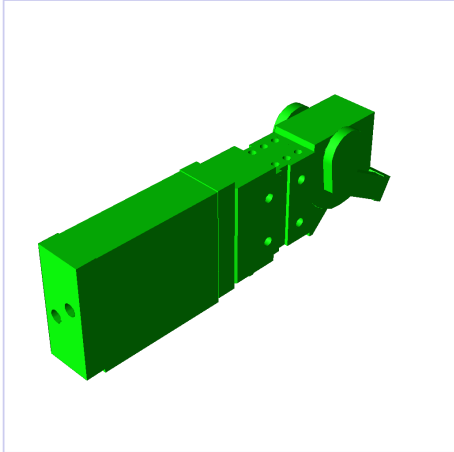

[ctlf_63_120_fw_ph_xc.stp](#)
99.84 %

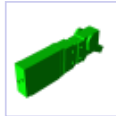

[ctlf_63_120_fw_ph_xc.igs](#)
99.83 %

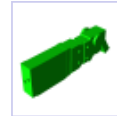

[ctlf_63_060_fw_pv_xc.stp](#)
88.09 %

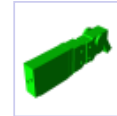

[ctlf_63_060_fw_pv_xc.igs](#)
87.94 %

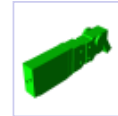

[ctlf_63_060_fw_pv_xc.prt](#)
87.92 %

Name

Similar parts

9965. [dseu_50_200_p_a.stp](#) (2 members)

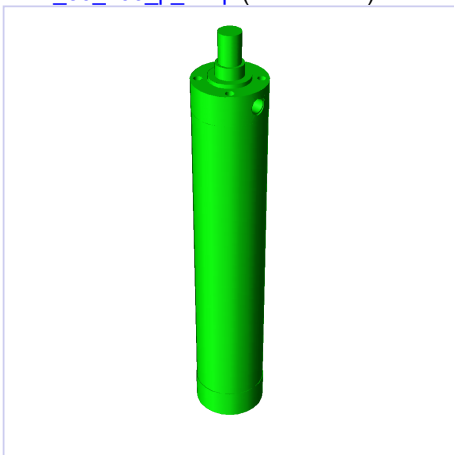

DSEU_50_200_P_A.model
92.72 %

9966. [DSEU_50_200_P_A.model](#) (2 members)



dseu_50_200_p_a.stp
92.72 %

9967. [advc_080_10_a_p_a.stp](#) (11 members)

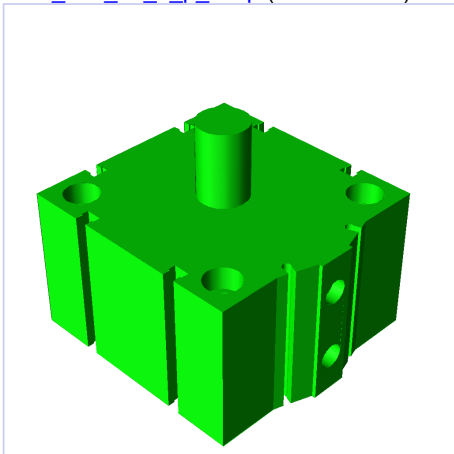

advc_080_10_a_p_a.prt
99.65 %

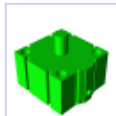

aevc_080_10_a_p_a.prt
97.99 %

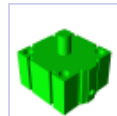

aevc_080_10_a_p_a.stp
97.95 %

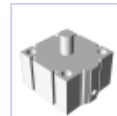

AEVC_080_10_A_P_A.model
97.68 %

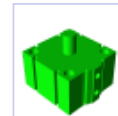

advc_080_20_a_p.stp
96.06 %

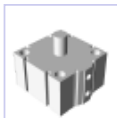

ADVC_080_20_A_P.model
95.78 %



advc_080_15_a_p_a.stp
85.78 %



advc_080_15_a_p_a.prt
85.74 %

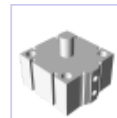

ADVC_080_15_A_P.model
85.30 %

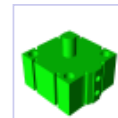

advc_080_15_a_p.stp
85.25 %

Name
 9968. [SLZ_25_100_KF_A_G.model](#) (8 members)



Similar parts



slz_25_100_kf_a_g.igs
96.80 %



slz_25_100_kf_a_g.prt
96.75 %



slz_25_100_kf_a_g.stp
96.63 %



SLZ_20_100_KF_A_G.model
91.23 %



slz_20_100_kf_a_g.igs
89.28 %



slz_20_100_kf_a_g.stp
89.17 %



slz_20_100_kf_a_g.prt
89.16 %

9969. [feng_050_160_kf.igs](#) (6 members)

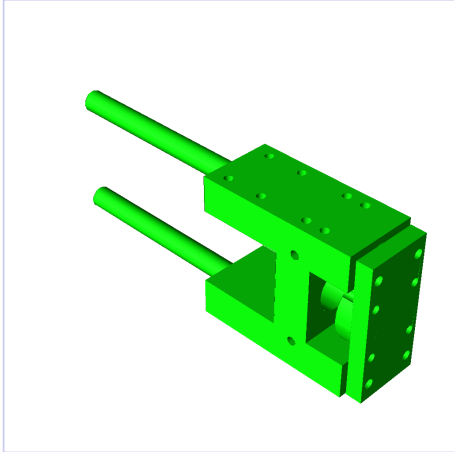

feng_050_160_kf.prt
99.76 %

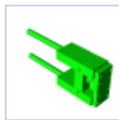

feng_050_160_kf.stp
99.72 %



feng_050_160.stp
88.15 %

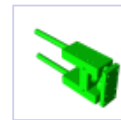

feng_050_160.prt
88.10 %

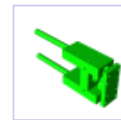

feng_050_160.igs
87.83 %

9970. [advc_040_25_ip_a.stp](#) (5 members)

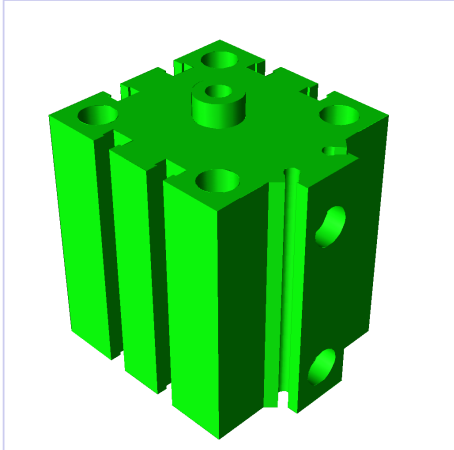

ADVC_040_25_IP_A.model
98.50 %



aevc_040_25_ip_a.stp
90.97 %



aevc_040_25_ip_a.prt
90.78 %



AEVC_040_25_IP_A.model
90.57 %

Name
9971. [dng_080_250_ppv_a.stp](#) (2 members)

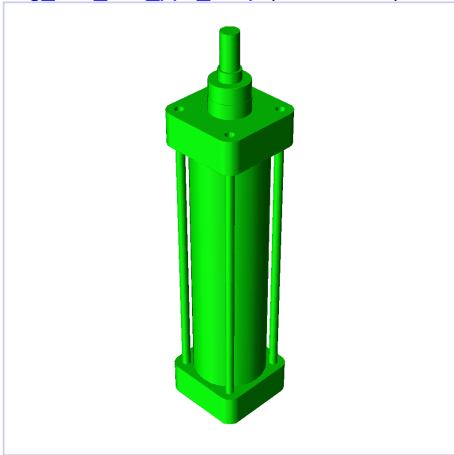

Similar parts



DNG_080_250_PPV_A.model
92.70 %

9972. [DNG_080_250_PPV_A.model](#) (2 members)

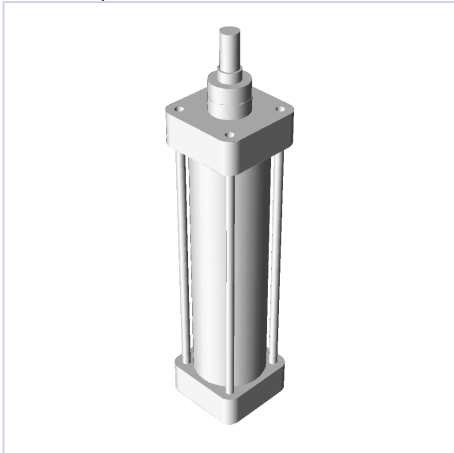

dng_080_250_pv_a.stp
92.70 %

9973. [feng_050_160.stp](#) (6 members)

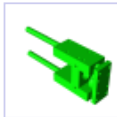
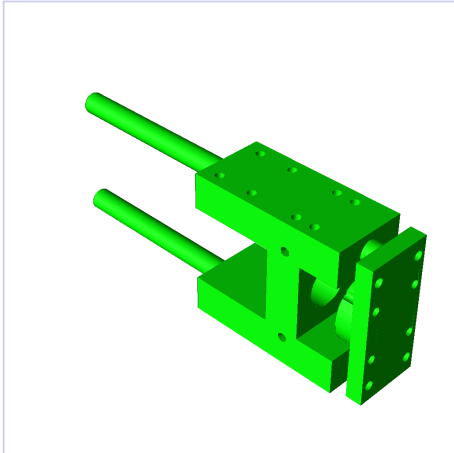

feng_050_160.prt
99.88 %

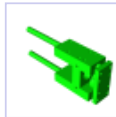

feng_050_160.igs
99.48 %

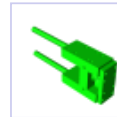

feng_050_160_kf.igs
88.15 %

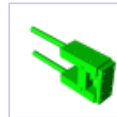

feng_050_160_kf.prt
88.03 %

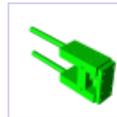

feng_050_160_kf.stp
87.96 %

Name
 9974. [AEVU_050_20_A_P_A_S2.model](#) (7 members)

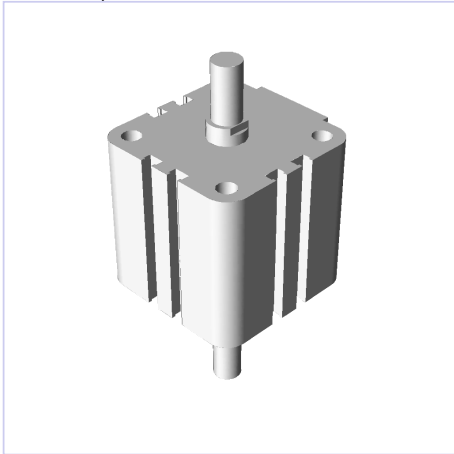

Similar parts



AEVULQ_050_20_A_P_A_S2.model
 99.21 %



aevu_050_20_a_p_a_S2.stp
 98.91 %



aevulq_050_20_a_p_a_S2.stp
 98.76 %



advulq_050_020_a_p_a_s2.prt
 87.74 %



AEVULQ_050_20_A_P_A_S20.model
 85.78 %

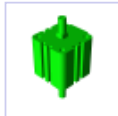

aevulq_050_20_a_p_a_S20.stp
 85.77 %

9975. [aevc_004_025_a_p.prt](#) (5 members)

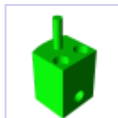
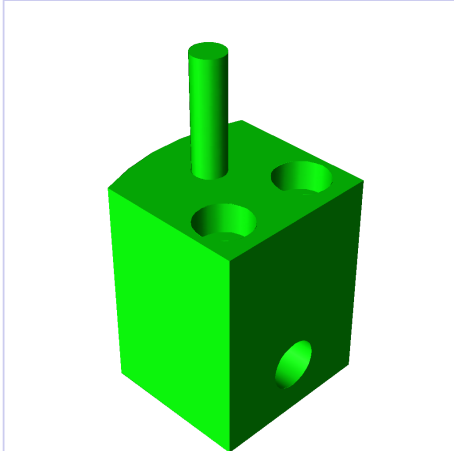

aevc_004_025_a_p.stp
 99.78 %

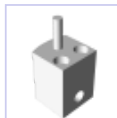

AEVC_004_025_A_P.model
 98.79 %



ADVC_004_025_A_P.model
 86.29 %

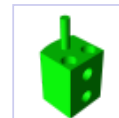

advc_004_025_a_p.stp
 85.92 %

9976. [ADVC_016_05_A_P_A.model](#) (4 members)

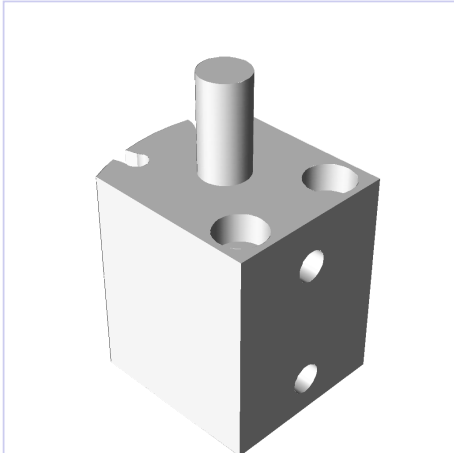

aevc_016_05_a_p_a.prt
 92.79 %

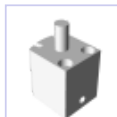

AEVC_016_05_A_P_A.model
 92.68 %



aevc_016_05_a_p_a.stp
 92.61 %

Name
9977. [qh_qs_4_1-8_pn153486.prt](#) (5 members)

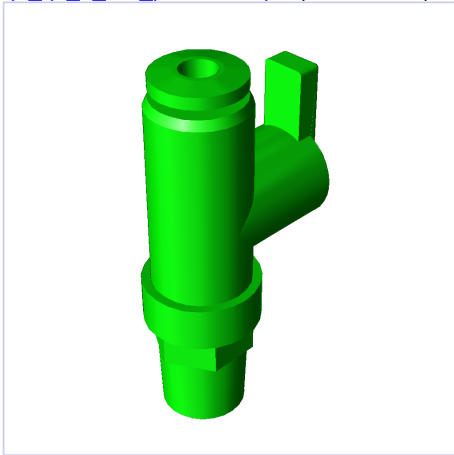

Similar parts



qh_qs_4_1-8_pn153486.stp
99.70 %



qh_qs_4_1-8_pn153486.igs
99.14 %



qh_qs_6_1-8_pn153487.prt
86.08 %



qh_qs_6_1-8_pn153487.stp
85.81 %

9978. [ADVULQ_080_10_P_A.model](#) (14 members)

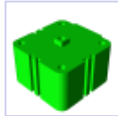
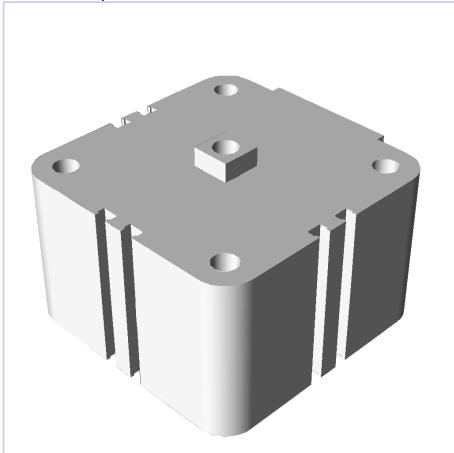

advulq_080_10_p_a.stp
99.18 %

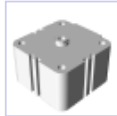

ADVU_080_10_P_A.model
99.08 %

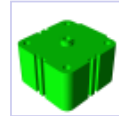

advu_080_10_p_a.stp
98.61 %

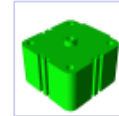

advu_080_010_p_a_pn156568.prt
98.53 %

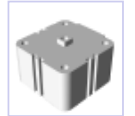

AEVULQ_080_10_P_A.model
96.01 %

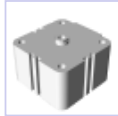

AEVU_080_10_P_A.model
95.91 %



aevulq_080_10_p_a.stp
95.75 %

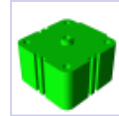

aevu_080_10_p_a.stp
95.55 %

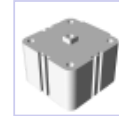

ADVULQ_080_15_P_A.model
85.44 %

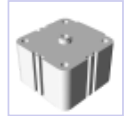

ADVU_080_15_P_A.model
85.43 %

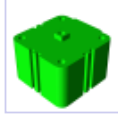

advulq_080_15_p_a.stp
85.16 %

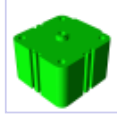

advu_080_015_p_a_pn156569.prt
85.12 %

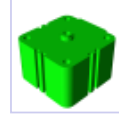

advu_080_15_p_a.stp
85.10 %

9979. [feng_050_160.prt](#) (6 members)

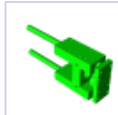
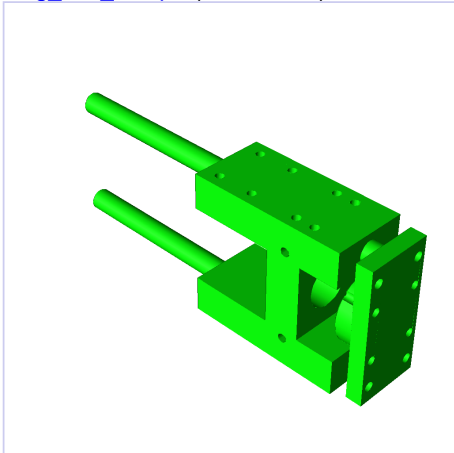

feng_050_160.stp
99.88 %



feng_050_160.igs
99.54 %

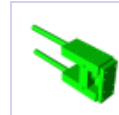

feng_050_160_kf.igs
88.10 %

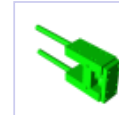

feng_050_160_kf.prt
87.98 %

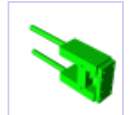

feng_050_160_kf.stp
87.90 %

Name
 9980. [AEVULQ_063_10_A_P_A.model](#) (12 members)

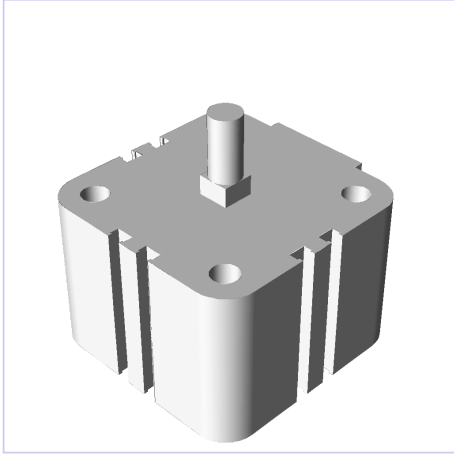

Similar parts

aevu_063_10_a_p_a.stp 99.38 %	AEVU_063_10_A_P_A.model 99.05 %	aevu_063_10_a_p_a.stp 98.70 %	ADVULQ_063_10_A_P_A.model 95.66 %	advulq_063_10_a_p_a.stp 95.37 %
ADVU_063_10_A_P_A.model 95.26 %	advu_063_10_a_p_a.stp 94.97 %	AEVULQ_063_15_A_P_A.model 85.40 %	aevulq_063_15_a_p_a.stp 85.31 %	AEVU_063_15_A_P_A.model 85.26 %
aevu_063_15_a_p_a.stp 85.13 %				

9981. [aevulq_050_20_a_p_a_S2.stp](#) (7 members)

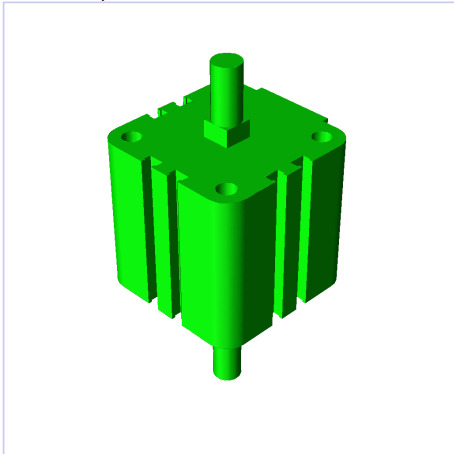

AEVULQ_050_20_A_P_A_S2.model 99.26 %	aevu_050_20_a_p_a_S2.stp 99.23 %	AEVU_050_20_A_P_A_S2.model 98.76 %	advulq_050_020_a_p_a_s2.prt 87.47 %	aevulq_050_20_a_p_a_S20.stp 85.76 %
AEVULQ_050_20_A_P_A_S20.model 85.58 %				

9982. [advc_032_10_a_p.stp](#) (7 members)

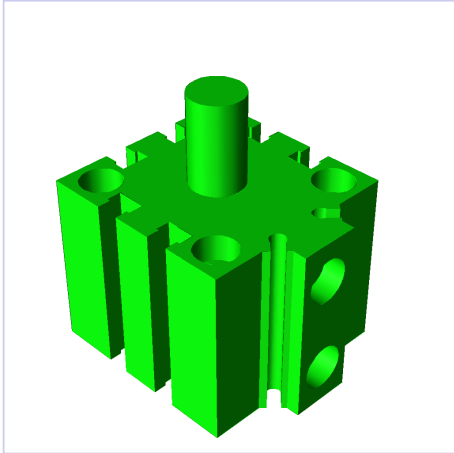

ADVC_032_10_A_P.model 98.74 %	advc_032_05_a_p_a.stp 92.87 %	ADVC_032_05_A_P_A.model 92.61 %	aevc_032_05_a_p_a.prt 90.68 %	aevc_032_05_a_p_a.stp 90.64 %
AEVC_032_05_A_P_A.model 90.51 %				

Name
9983. [advc_080_10_a_p_a.prt](#) (11 members)

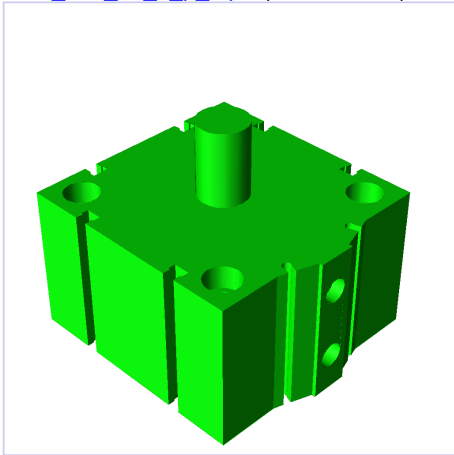

Similar parts

advc_080_10_a_p_a.stp 99.65 %	aevc_080_10_a_p_a.prt 97.94 %	aevc_080_10_a_p_a.stp 97.83 %	AEVC_080_10_A_P_A.model 97.59 %	advc_080_20_a_p.stp 96.00 %
ADVC_080_20_A_P.model 95.83 %	advc_080_15_a_p_a.prt 85.79 %	advc_080_15_a_p_a.stp 85.78 %	ADVC_080_15_A_P.model 85.18 %	advc_080_15_a_p.stp 85.11 %

9984. [ctlf_63_120_fw_ph_xc.stp](#) (6 members)

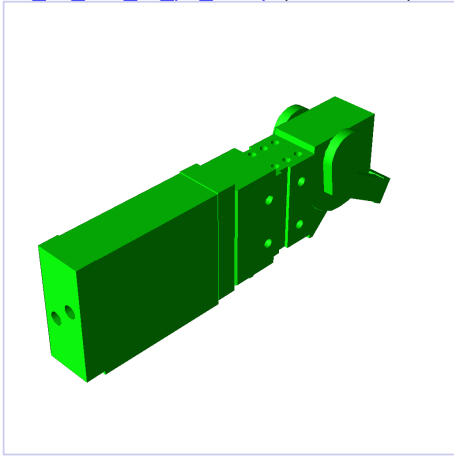

ctlf_63_120_fw_ph_xc.prt 99.84 %	ctlf_63_120_fw_ph_xc.igs 99.73 %	ctlf_63_060_fw_pv_xc.stp 88.04 %	ctlf_63_060_fw_pv_xc.igs 87.88 %	ctlf_63_060_fw_pv_xc.prt 87.87 %

9985. [feng_050_160_kf.prt](#) (6 members)

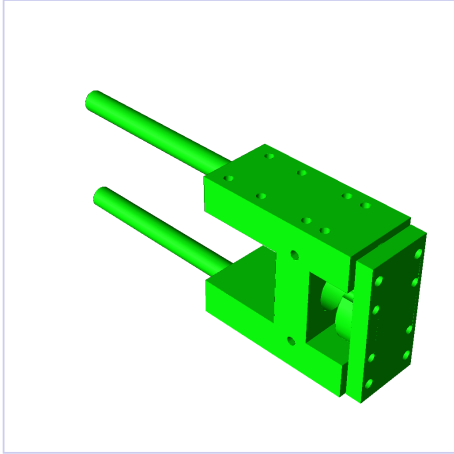

feng_050_160_kf.stp 99.85 %	feng_050_160_kf.igs 99.76 %	feng_050_160.stp 88.03 %	feng_050_160.prt 87.98 %	feng_050_160.igs 87.72 %

Name
 9986. [AEVU_080_25_P_A.model](#) (13 members)

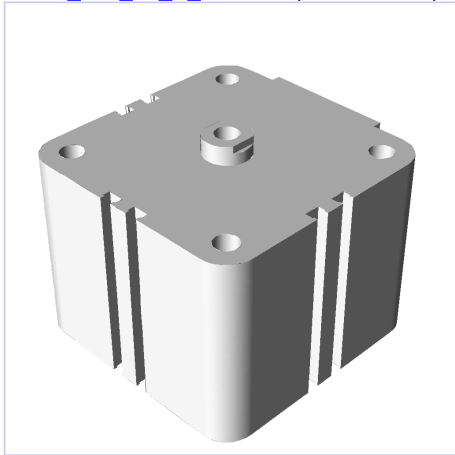

Similar parts

AEVULQ_080_25_P_A.model 98.67 %	aevu_080_25_p_a.stp 97.40 %	aevulq_080_25_p_a.stp 96.71 %	ADVU_080_25_P_A.model 96.46 %	ADVULQ_080_25_P_A.model 96.28 %
advu_080_25_p_a.stp 94.80 %	advu_080_025_p_a_pn156571.prt 94.74 %	advulq_080_25_p_a.stp 94.59 %	aevulq_080_20_p_a.stp 85.67 %	aevu_080_20_p_a.stp 85.64 %
AEVU_080_20_P_A.model 85.52 %	AEVULQ_080_20_P_A.model 85.47 %			

9987. [aevuz_012_10_a_p_a.stp](#) (4 members)

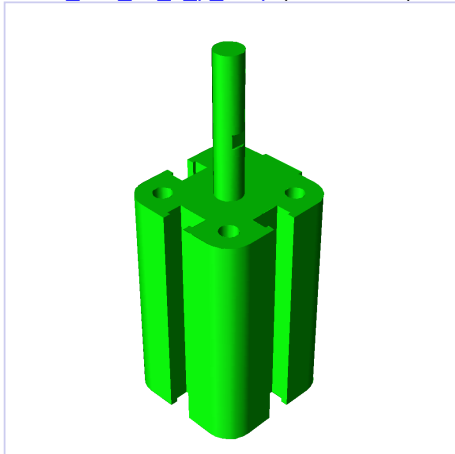

AEVUZ_012_10_A_P_A.model 98.58 %	aevuz_016_10_a_p_a.stp 90.06 %	AEVUZ_016_10_A_P_A.model 89.30 %

9988. [ADVC_032_10_A_P.model](#) (7 members)

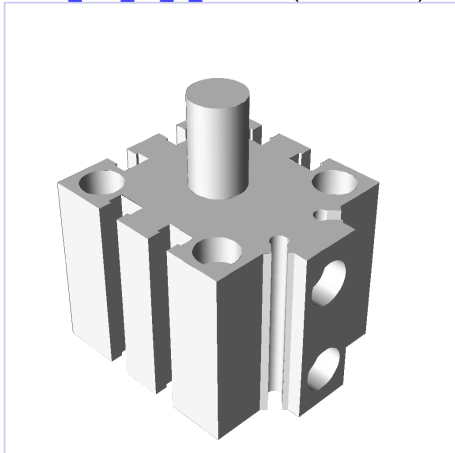

advc_032_10_a_p.stp 98.74 %	ADVC_032_05_A_P_A.model 92.84 %	advc_032_05_a_p_a.stp 92.46 %	AEVC_032_05_A_P_A.model 90.84 %	aevc_032_05_a_p_a.prt 90.53 %
aevc_032_05_a_p_a.stp 90.46 %				

Name
 9989. [ctlf_63_060_fw_pv_xc.prt](#) (6 members)

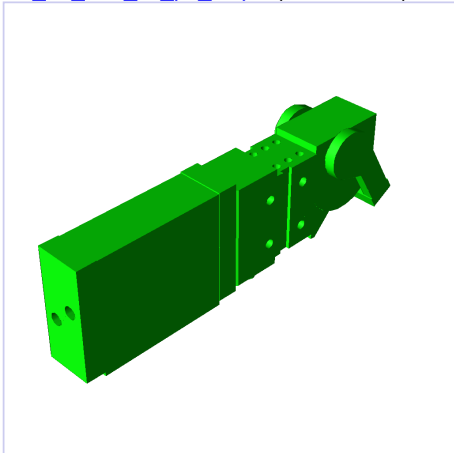

Similar parts

ctlf_63_060_fw_pv_xc.stp 99.85 %	ctlf_63_060_fw_pv_xc.igs 99.75 %	ctlf_63_120_fw_ph_xc.prt 87.92 %	ctlf_63_120_fw_ph_xc.stp 87.87 %	ctlf_63_120_fw_ph_xc.igs 87.81 %

9990. [ctlf_63_120_fw_ph_xc.igs](#) (6 members)

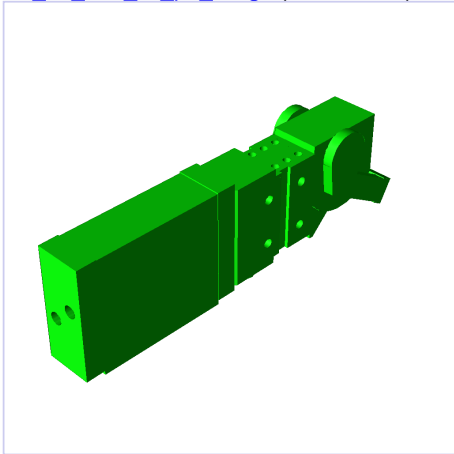

ctlf_63_120_fw_ph_xc.prt 99.83 %	ctlf_63_120_fw_ph_xc.stp 99.73 %	ctlf_63_060_fw_pv_xc.stp 87.98 %	ctlf_63_060_fw_pv_xc.igs 87.84 %	ctlf_63_060_fw_pv_xc.prt 87.81 %

9991. [aevulq_040_20_a_p_a.stp](#) (13 members)

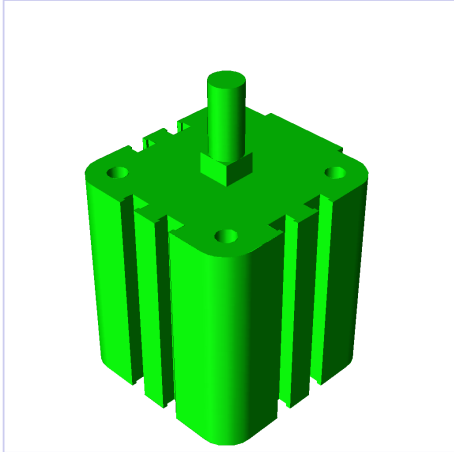

aevu_040_20_a_p_a.stp 99.49 %	AEVULQ_040_20_A_P_A.model 99.31 %	AEVU_040_20_A_P_A.model 99.21 %	advu_040_20_a_p_a.stp 94.08 %	ADVU_040_20_A_P_A.model 94.03 %
ADVULQ_040_20_A_P_A.model 93.94 %	advulq_040_20_a_p_a.stp 93.89 %	AEVUZ_040_20_P_A.model 91.06 %	aevuz_040_20_p_a.stp 91.03 %	aevu_040_20_p_a_S2.stp 85.47 %
aevulq_040_20_p_a_S2.stp 85.05 %	AEVU_040_20_P_A_S2.model 85.05 %			

Name
9992. [ctlf_50_030_fr_pv_xc.prt](#) (4 members)

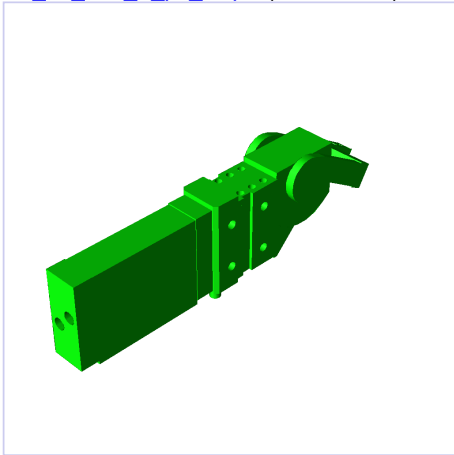

Similar parts



ctlf_50_030_fl_p v_xc.igs	ctlf_50_030_fl_p v_xc.stp	ctlf_50_030_fl_p v_xc.prt
92.65 %	92.63 %	92.60 %

9993. [DSL_40_025_270_P_S20_FF_KF.model](#) (6 members)

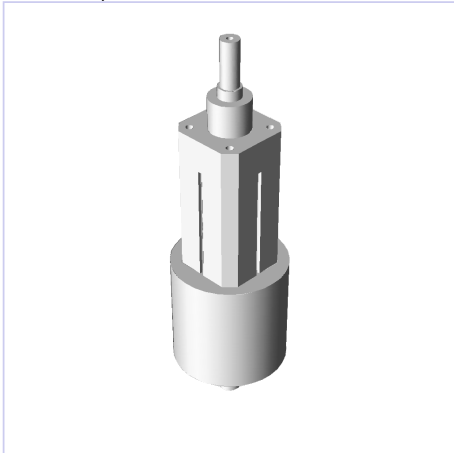

dsl-40-025-270- p-s20-ff-kf.stp	dsl_40_025_270 _p_s20_ff_kf.prt	DSL_40_040_2 70_P_S20_FF_ KF.model	dsl-40-040-270- p-s20-ff-kf.stp	dsl_40_040_270 _p_s20_ff_kf.prt
98.64 %	98.60 %	89.47 %	88.21 %	88.17 %

9994. [ctlf_63_060_fw_pv_xc.igs](#) (6 members)

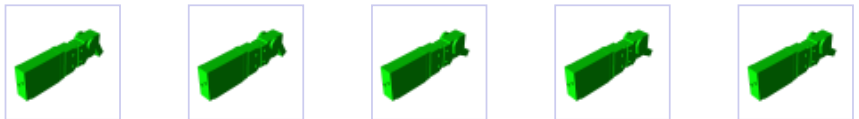
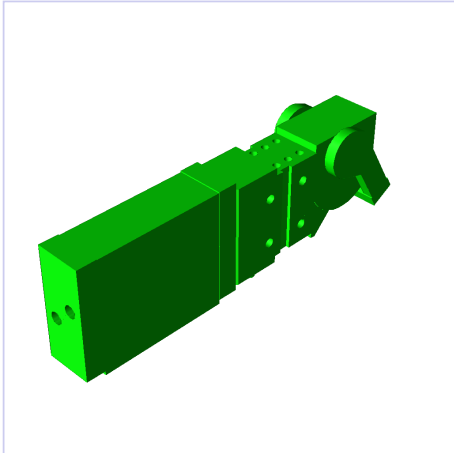

ctlf_63_060_fw_ pv_xc.prt	ctlf_63_060_fw_ pv_xc.stp	ctlf_63_120_fw_ ph_xc.prt	ctlf_63_120_fw_ ph_xc.stp	ctlf_63_120_fw_ ph_xc.igs
99.75 %	99.68 %	87.94 %	87.88 %	87.84 %

Name
 9995. [aevu_012_05_a_p_a_S2.stp](#) (3 members)

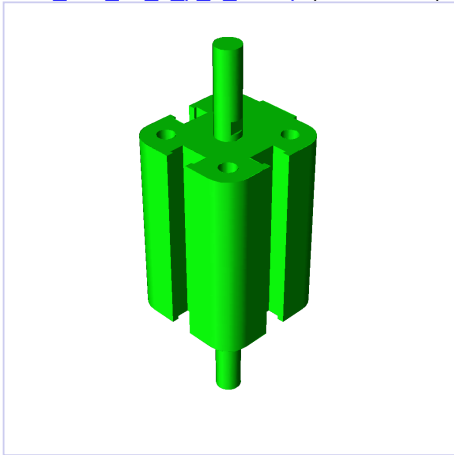

Similar parts



AEVU_012_05_A_P_A_S2.mod
el

98.83 %



aevu_012_05_a_p_a_S20.stp

86.40 %

9996. [feng_050_160_kf.stp](#) (6 members)

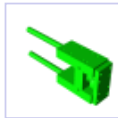
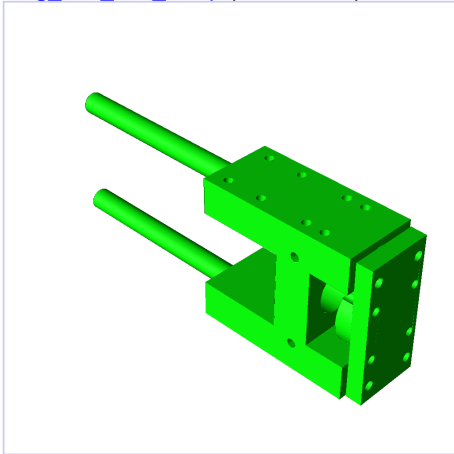

feng_050_160_kf.prt

99.85 %

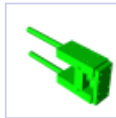

feng_050_160_kf.igs

99.72 %

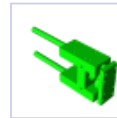

feng_050_160.stp

87.96 %



feng_050_160.prt

87.90 %

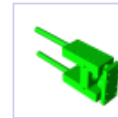

feng_050_160.igs

87.64 %

9997. [aevulq_080_10_a_p_a.stp](#) (18 members)

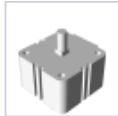
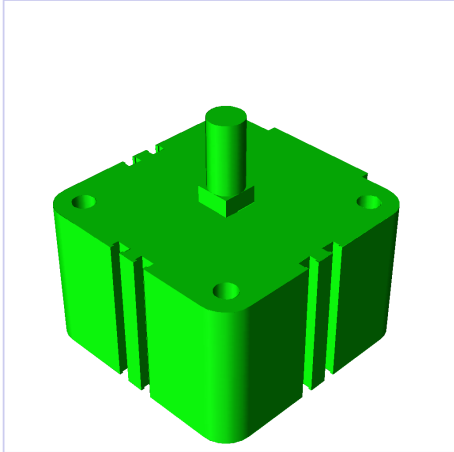

AEVULQ_080_10_A_P_A.model

99.36 %

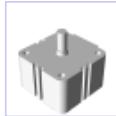

AEVU_080_10_A_P_A.model

99.15 %

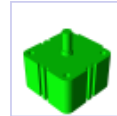

aevu_080_10_a_p_a.stp

99.10 %

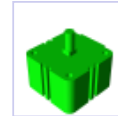

advulq_080_10_a_p_a.stp

97.89 %

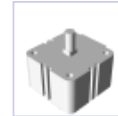

ADVULQ_080_10_A_P_A.model

97.63 %

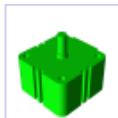

advu_080_10_a_p_a.stp

97.57 %

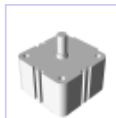

ADVU_080_10_A_P_A.model

97.55 %

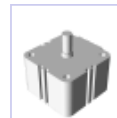

AEVU_080_15_A_P_A.model

89.23 %

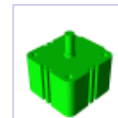

advu_080_15_a_p_a.stp

89.15 %

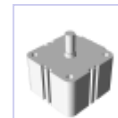

ADVU_080_15_A_P_A.model

89.10 %

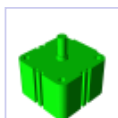

aevu_080_15_a_p_a.stp

89.02 %

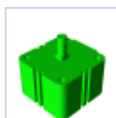

advulq_080_15_a_p_a.stp

88.98 %

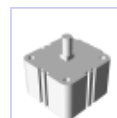

AEVULQ_080_15_A_P_A.model

88.88 %

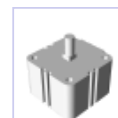

ADVULQ_080_15_A_P_A.model

88.86 %



aevulq_080_15_a_p_a.stp

88.84 %



aevuz_080_10_a_p_a.stp

87.11 %

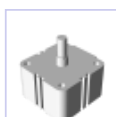

AEVUZ_080_10_A_P_A.model

86.95 %

Name
 9998. [dsl_25_080_270_p_s20_ff_kf.prt](#) (5 members)

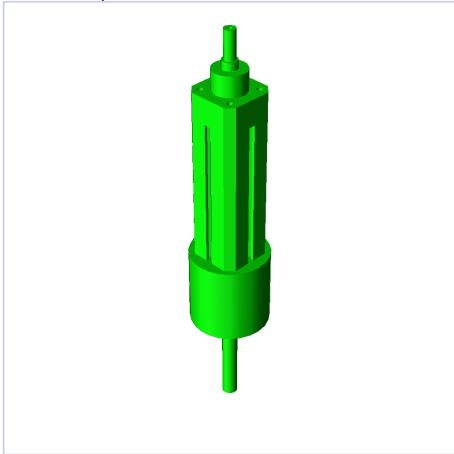

Similar parts

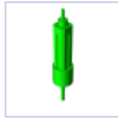

dsl-25-080-270-p-s20-ff-kf.stp
 100.00 %

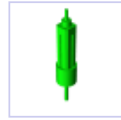

dsl-25-100-270-p-s20-ff.stp
 92.03 %

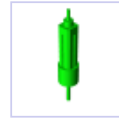

dsl_25_100_270_p_s20_ff.prt
 92.02 %



DSL_25_080_270_P_S20_FF_KF.m
 odel
 86.37 %

9999. [ADVULQ_025_200_A_P_A_S20.model](#) (6 members)



ADVU_025_200_A_P_A_S20.m
 odel
 98.57 %



advulq_025_200_a_p_a_S20.stp
 96.41 %



advu_025_200_a_p_a_S20.stp
 96.02 %



advulq_025_200_a_p_a_S2.stp
 86.31 %



ADVULQ_025_200_A_P_A_S2.model
 85.69 %

10000. [DGEA_40_500_ZR_WB_KH.stp](#) (3 members)

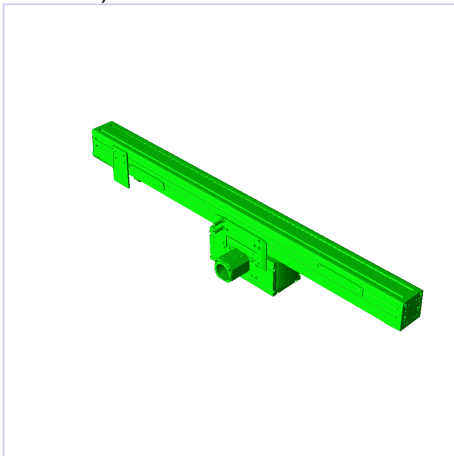

DGEA_40_500_ZR_WB_KV.stp
 97.26 %



DGEA_40_500_ZR_WH_KH.stp
 87.95 %